



Material Removal Tools Training Manual



A Message from Global Power Tools President



Ross Porter
President,
Global Power Tools
Apex Tool Group

Dear Distribution Partner,

We are excited to announce the launch of our Cleco University power tools training. As part of our continued commitment to growth through distribution, this training program will cultivate a stronger understanding of our product offering and equip our distribution partners to advise their customers on the right tool for their specific application. By providing ongoing training and resources, your team will have the edge they need to be successful.

Something else you may have noticed. We have branded this training manual with a new logo combination of Cleco® and Dotco®. This reflects a new branding approach we are taking at Apex Tool Group with our power tool brands consolidating under the Cleco® brand. Dotco® will migrate to a product family brand under the Cleco® banner.

We look forward to your continued partnership and the impact we will make together. Collectively, we will focus our efforts to provide end customers with the highest quality solutions and service in the industry. Thank you for your participation in the Training Empowered Sales Program.

Sincerely,

Ross Porter
President, Global Power Tools

Cleco® University Mission

To provide our distribution partners a platform for learning that will empower them with the ability to communicate critical product detail, application specific recommendations and benefits to end-users.

Table of Contents

1. Introduction	4	6. How Pneumatic Tools Work	37
Let's Help the Customer!	5	Basics of Pneumatics	38
Training Guidelines	6	Compressed Air Systems - Basic Terminology	39
<hr/>		Pneumatic System Infrastructure	40
2. Good Customer Relations	7	Pneumatic Systems	41
The Power of Partnership	8	5 Key Considerations When Selling	
Customer Service	9	Pneumatic Tools	44
Engineering and Manufacturing Support	9	Common Pneumatic Tool Brands	45
Value Selling	11	Motor Types For Pneumatic Tools	46
Value of a Good Partner	12	Rotary Vane Motor	46
Success Stories	13	Rotary Vane Motor Operation	47
The Total Value Package	16	Linear Piston Motor	48
<hr/>		Percussion Tools	48
3. Global Power Tools Overview	17	Other Pneumatic Tools	49
About Global Power Tools	18	Commonalities of All Pneumatic Tools	50
Industry Focused Solutions	19	Motor Power to Tool Configurations	51
Motor Vehicle Industry Overview	20	Commonalities in Different Pneumatic	
Aerospace Industry Overview	21	Tool Configurations	52
General Industry Overview	22	Interesting Pneumatic Tool Facts	53
Product Overview for Vehicle Markets	23	<hr/>	
<hr/>		7. Introduction to Material Removal	54
4. Global Power Tools General Safety	24	Overview	55
Safety From Noise	25	Terminology	56
Safety Guards and Throttles	26	Grinding and Sanding Overview	58
Safety Labels	27	Precision Die Grinding and Deburring	58
<hr/>		Rough Grinding and Cutting Off	62
5. Ergonomics	31	Sanding and Polishing	67
What are Cumulative Trauma Disorders?	32	Hand-held Drilling	70
Cumulative Trauma Disorders Defined	33	Percussion and Specialty Tools	74
Ergonomic Areas of Concern	34	Basic Troubleshooting For Pneumatic Tools	78
Ergonomics As It Applies to Material Removal	36	Dotco® Specific Model Numbering System	79
		Cleco® Specific Model Numbering System	80



Introduction



Let's Help the Customer!

Isn't every business operation in existence because of customers? You, as product salespeople, and we, as a product supplier, are in business to make a profit and, to do this we must help the customer. If we can't help him, he doesn't need us. So let's help the customer!

How?

By increasing his profits with these **benefits**:

- *Good customer relations*
- *The right tool for the job*
- *Safety on the job*
- *High productivity*
- *Low maintenance*

Over the years, studies have consistently proven that people don't buy products – they buy **benefits**. This is especially true in industries where profits are closely watched by all the key people who influence buying. These people need help and they expect salespeople to get right to the point on "How will we benefit by buying from you?"

People don't buy products – they buy benefits.

So, let's get to the point and discuss "BENEFITS" in detail. In doing this, we will be talking about the attributes of:

- *Our salespeople (you)*
- *Our customer service*
- *Our advertising and sales promotion*
- *Our engineering and manufacturing*
- *And our **product***

which provide benefits to our customers.

The newly revised and expanded Cleco-Dotco[®] Material Removal Training Manual – and your wholehearted use of it – will make the big difference in your sales and in your customers satisfaction.

Rich in important information, this sales-making manual is designed to help you meet those critical applications and tool selection problems your customers depend on you solving.



Training Guidelines

Follow these guidelines to make the most of this training:

- **Study It**

...and learn those all-important benefits. Individual sections in this manual will give you the solid background you need to help your customers cut costs.

- **Review It**

... and you will stay fresh. Take a few minutes each week and you will always know where and how to spot customer needs, and how to match them with benefits. Push the “hot button” on real customer needs and you will make the sale.

- **Update It**

...and stay on top of the market. As new data sheets and revisions are made available, it becomes a continuing source of the newest promotional, technical, and sales ideas. It gives you new benefits to talk about on each sales call.

- **Restrict Its Distribution**

...and you will slow down competition. Intended solely as an idea and information source for you, the Cleco-Dotco® products representative, it contains proprietary information. Deny the competition access to your plans and activities and you will make your own selling job easier.

- **Do Not**

...show it to or leave it with customers or allow outside access to it.

- **Bring It To Class**

...where you will use it as a guide for in-depth product application sessions, air tool operation training, equipment troubleshooting, and guided group discussion of field problems.

We sincerely believe that the customer benefit story found in this manual will make your selling job richer and more rewarding. Knowing you have pleased the customer and made the sale is the greatest reward a professional salesperson can receive.

Best regards and good selling!



Good Customer Relations

2



You, the Distributor Sales Representative

A product does nothing by itself. It cannot help the customer unless there are topflight distributor salespeople or factory representatives to demonstrate, sell, and service the product. These salespeople are absolutely essential for good customer relations.

The customer really needs the sales person to study their operation and show them how to increase their productivity.

A major part of selling Cleco-Dotco® power tools is done in the manufacturing area to the foreman or superintendent. Purchasing, an important plant function, also must be involved.

The keys to excellent customer relations are:

Know The Applications

- *Our products drive all types of cutting and finishing tools: burrs, bonded and coated abrasives, buffs, router bits, saw blades, drills, etc.*
- *Know which tools to use with various cutting tools*
- *Search for new applications*
- *Be cognizant of your customer's new requirements*
- *Keep abreast of new cutting tools for use with our tools.*

Know Your Customers:

- *What do they do and how?*
- *What cutting tools do they use?*
- *Ask yourself, "What do I have to do it better?"*
- *Before demonstrating, make sure you have the right tool.*

Know How To Demonstrate:

- *Become experienced in demonstrating various tools*
- *Make recommendations*
- *Ask questions like, "Have you considered...?"*
- *Shop people are knowledgeable – if you are not sure, get help. Contact the factory if necessary.*

Your track record is excellent – **continue helping the customer by maintaining good customer relations.**

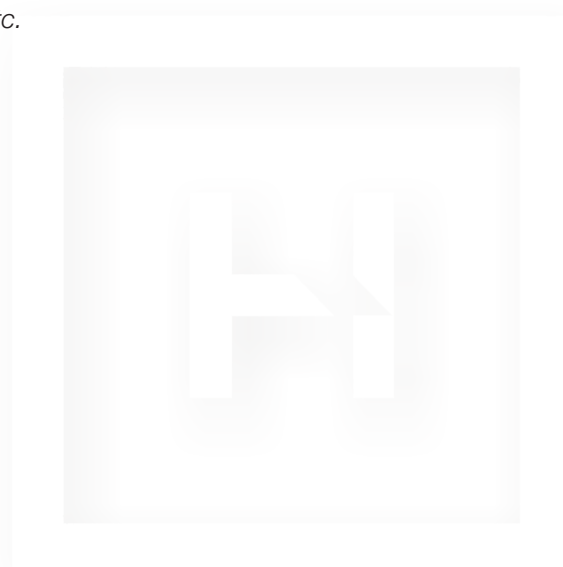

Customer Service

Keeping the customer requires providing good service. Getting that order from a new, or old, customer is only the beginning.

Prompt quotations, correct ordering, conscientiously checking and following up on deliveries, performing and handling tests efficiently, and offering helpful recommendations are a few requisites for good service.

Be in a position to help the customer. A visit or a few phone calls may save the day. Be familiar with the customer service facility for Cleco-Dotco® products.

Order Service

When entering an order, you may want to contact customer service direct:

Cleco-Dotco® Products

Within South Carolina: 1-803-951-7500

Outside of South Carolina: 1-800-845-5629

Fax: 1-803-359-0822

Any of these numbers will put you straight to customer service. Orders are acknowledged if they cannot be shipped within three working days. Customer service – equipped with up-to-date information on order status, delivery information, catalogs, prices, changes, and service parts – can answer your questions.

Repair

Cleco-Dotco® tools, returned to the plant, are repaired and shipped within 48 hours after they are received. Charges are made for replaced service parts plus the repair labor.

Build good customer relations – help the customer.

Engineering & Manufacturing Support

Management's Philosophy

Cleco-Dotco® power tools products are developed with the philosophy to "Help the Customer." The design and manufacture of Cleco-Dotco® tools provide the customers with the products they need.

Listen to the needs of the customer and develop the right tool for the job. You will be offering greater operator safety and comfort for increased productivity and lower tool maintenance at the lowest possible price.

Facilities

Apex Tool Group is equipped to design, test, and manufacture the full portfolio of Cleco-Dotco® power tool products. Prototypes are machined in the model shop and evaluated in the engineering lab, which has equipment for testing material strength and bearings, fatigue, performance analysis, and sound measurements. After meeting engineering standards, new products are evaluated by salespeople in the field. Upon satisfactory results, new products are released to manufacturing.

The product manager, manufacturing engineer and the methods analyst determine how products are manufactured to the highest quality standards, and at the lowest cost consistent with those standards.

Tools are manufactured by the finest up-to-date equipment and technology to give the customer top quality and service. Apex Tool Group manufacturing plants are modern in all respects – well lighted and fully air-conditioned.

The Quality Control Department has highly-trained personnel and sophisticated equipment to give it broad capability – from precision dimensional measurements to hardness testing to metallurgical analysis of materials.

Data Processing (using input from marketing, engineering, manufacturing, quality control, and accounting) provides information for market analysis, production scheduling and control, and cost accounting. Order acknowledgments, shipping documents, invoicing, and payroll are also computerized.

Apex Tool Group maintains a conscientious program of quality control, O.P.C., and continued progress in engineering new products and improvements in existing products will help Cleco-Dotco® brand remain the leader in material removal products.

Apex Tool Group facilities are geared to do one thing – **build quality products and improve customer relations.**

**Value Selling**

Value selling is one of the most important sales conversations in business today. It involves understanding and knowing what your prospects value and need in their everyday business functions, and how they measure ROI to determine value. By matching product to their needs with ROI they can measure where you bring value to their operation. It begins with asking questions – a lot of questions.

Questions To Qualify

In the value sales process there is a need to first “qualify” the customer. This is a matter of determining if the prospect is in need of what you have to offer. Some basic questions can determine this quickly and save both of you from wasting a lot of time. There is nothing worse than having prospects feel they are being sold something they don’t need.

The Cleco® University training program is designed to give you the knowledge of Cleco-Dotco® material removal tools and related systems so you can ask your customers more pointed questions like:

Is your production use high enough and are there metrics in place that you will be able to quickly measure the ROI on a Cleco-Dotco® grinder or drill?

A result of the qualifying process is to allow you to place your prospect into a sales segment, which helps evaluate if their needs are good match for your product offerings.

Tool Usage Segments

In the use of industrial tools, your qualifying questions should determine which segment your prospect best fits into.

DIY/Hobby

As the name implies, you will find:

- Tools used only occasionally
- Tool performance that is not tied directly to profitability
- Tools used for a variety of tasks
- Applications are pretty simple and require basic performance

Repair/Trades

The needs go up as:

- Tools are used daily or weekly
- Tool performance becomes tied loosely to profitability
- Tools are still used for a variety of tasks
- Applications require basic and some performance qualities

Knowing the Apex Tool Group power tools portfolio, you may already have concluded that these first two segments are not an ideal match for our Cleco-Dotco® material removal tools.



Core Segments

As part of our business focus, we have core segments of the industrial tool market that operate as our our sweet spot for business performance. The needs of these core segments align best with the high performance, durable tools we offer. They include:

General Industrial and MVI/Aerospace

Both of these segments require tools that:

- Are used daily for multiple shifts
- Tie performance directly to profitability
- Are used for specific tasks within a process
- Have applications that require accuracy and traceability
- Have replacement frequency is an important consideration

Value of a Good Partner



The majority of our customers do not buy our products based on price alone, they buy them based on quality, performance, and durability, which are explained below.

Durability

With an improvement in tool durability, the time and cost to repair and replace tools can be reduced significantly. Durability is truly one of our key differentiators from our competitors.



Productivity

Productivity is critical for any tool to reduce the re-work costs and also the warranty issues. Our tools are made for high productivity, which help in achieving the tight timelines and schedules.



Operator Safety

The ability to use any tool safely is paramount. Therefore our tools are designed to reduce worker fatigue and injury: taking into consideration all aspects of tool use including ergonomics, environment, weight, vibration, noise, temperature, and comfort design.



Service Support

To reduce downtime and lost productivity, we build our tool parts to be robust to lower failure rates. We also design our tools for ease of repair and parts commonality that allow for faster repairs and fewer parts stocked in repair inventory.



Success Stories

The following real case stories show how value was added to some of our customers operational ROI.



Tools that are Built to Last

Aerospace Application for Dotco® Precision Grinders

Situation: A major aerospace components manufacturer used grinders intensively throughout their processes for both de-burring and sanding/finishing for a mix of composites and aluminum. They use both in-line and right angle configurations. At one time they used 250 less-expensive competitive grinders, which only lasted 1-2 years.



Solution: They switched to Cleco-Dotco® grinders, which were lasting 5 years or longer. Now they buy only Cleco-Dotco® grinders.

Result: Their ROI metrics revealed an **annual replacement savings of \$28,000.**



Tools of Unmatched Productivity

Shipbuilding Application for Cleco® 1660 Grinders

Situation: A ship building operation used 1 HP angle grinders for 20 operators each on two shifts using the tools about 3 hours per day. They were looking to purchase new grinders with the goal to improve productivity.



Solution: They ran trials with the new Cleco® 1660 4" angle grinder.

Result: They realized a **productivity improvement of 40%**, which equaled an **annual productivity savings of \$336,000***.

Hourly rate estimate of \$35/hr.



Success Stories cont.



Tools Designed with the Operator in Mind

Safety Study of Cleco® Heritage Grinders

A comprehensive study was conducted to determine overall costs associated with strain injury. These injuries can occur when workers can use competitive grinders that can weigh 45% more than Cleco® Heritage Grinders. The study also showed that Cleco® offers the industry-leading power-to-weight ratios.

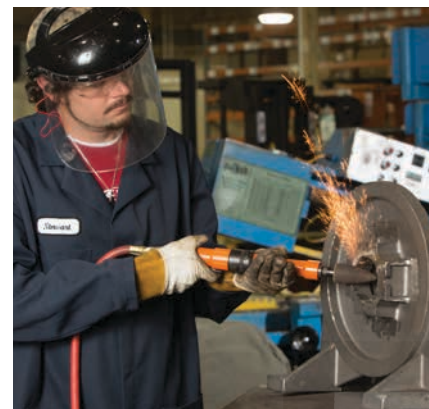

Solution: Grinders with the same power but less weight were easier/safer for operators to use, and reduced the risk of operator strain injuries and their direct and indirect expenses. Factors included:

- 30% profit margin
- Any wages paid to injured workers for absences not covered by workers' compensation
- The wage costs related to time lost through work stoppage associated with the worker injury
- The overtime costs necessitated by the injury
- Administrative time spent by supervisors, safety personnel, and clerical workers after an injury
- Training costs for a replacement worker
- Lost productivity related to work rescheduling, new employee learning curves, and accommodation of injured employees
- Clean-up, repair, and replacement costs of damaged material, machinery, and property

Some of the possible indirect costs not included in these estimates were:

- The costs of OSHA fines and any associated legal action
- Third-party liability and legal costs
- Worker pain and suffering
- Loss of good will from bad publicity

Result: Revealed an OSHA injury estimate of savings by avoiding per strain injury of **\$234,000**.



Success Stories cont.



A Team You Can Depend On

We have 30 professional material removal sales managers in North America plus 4 experienced technical/application specialists

Apex Tool Group Global Service Team Capabilities

Our focus is your satisfaction.

The Apex Tool Group Global Service Team is committed to your success. Customer service is one reason our customers choose Apex Power Tools products. We have both field/support team members as well as technical specialists to make sure your customers get the answers they need when they need them.



Apex Tool Group has the technical support resources to make recommendations on how to select the material removal tool that best suits the application, in order to get the best return on investment.

We're not satisfied until you are.

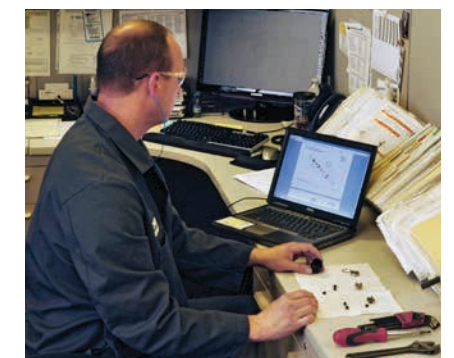

The Total Value Package

To wrap up this section focused on selling value to your existing customers and new prospects, remember these four building blocks and supporting examples:



1. Built to Last

Example: The aerospace application for Cleco-Dotco® Precision Grinders that lasted up to 4x longer than the competition and provided an annual replacement savings of \$28,000.



2. Unmatched Productivity

Example: The shipbuilding application for Cleco® 1660/2660 Series Angle Grinders that removed up to 2x more material than the competition with an annual productivity savings of \$336,000.



3. Designed for Safety

Example: The safety study of Cleco® Heritage Grinders that weighed 45% less than the competition while offering the same power output, saved \$234,000 per strain injury avoided.



4. Service Support

Example: Our dedicated Apex Tool Group Global Service Team support your customers with 30 material removal sales managers and 4 experienced technical/application specialists in North America.

In conclusion, savings and productivity are driven by our tools' performance, ergonomics, durability, and parts commonality.



Global Power Tools Overview



Background

We believe to understand our products is to understand our company story. We want you and your prospects to appreciate the long history we have in the development of industrial tools. Our story is about legacy brands that were built and merged over the decades. We think our experience and longevity sets us apart.

Apex Tool Group

Apex Tool Group is a leading global manufacturer of industrial power and professional hand tools. It was formed as a joint venture of Cooper Industries and Danaher by the merger of Cooper Tools and the Danaher's Tools and Components segment. In October 2012, Danaher and Cooper sold Apex to Bain Capital. Apex is headquartered in Sparks, Maryland, and has over 27 factories globally including the United States, Canada, Mexico, Germany, China, and South America.

Organizationally, Apex Tool Group is the parent to the Hand Tools Division consisting of dozens of well-known brands including Allen®, Armstrong®, and Crescent®. The other main division is Global Power Tools with respected industrial power tool brands like Cleco®, Cleco-Dotco®, Recoules Quackenbush®, and Weller®.

From a branding perspective, Apex Tool Group operates as a holding company that uses its tool brands as the face of the company.

Global Power Tools

The Global Power Tools division is home to numerous brands that have been divided into two categories: Strategic Brands and Product Families. The following are the Global Power Tools Strategic Brands:



Cleco®

Cleco is a global leader in manufacturing and delivering world-class assembly solutions including DC electric and pneumatic assembly tools, and pneumatic power motors.

Product Families include: DGD®, Livewire™, I-Wrench™, TULMan™



Dotco®

Formerly Dotco® now Cleco-Dotco® provides a broad offering of highly engineered material removal tools manufactured for industrial applications including grinders, sanders, drills, tube service tools, and more.

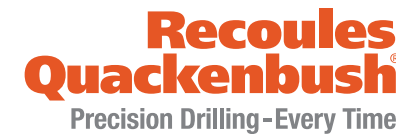

Recoules Quackenbush®

Recoules Quackenbush® is a global leader of precision drilling solutions and a manufacturer of a broad line of Advanced Drilling Equipment (ADE) and cutting tools in HSS, Carbide and PCD including drills, reamers, microstop cages, and drill/countersink cutters for the aerospace and automobile industries.

Product Families include: Advanced Drilling Equipment, Recoules Cutters®



Weller®

Weller® is a market leader in soldering technology, manufacturing high quality soldering and other “on-the-bench” tools for professionals and DIY.

Product Families include: Erem®, Xcelite®

Apex® Fastening Moves to IMS



Apex® Fastening Tools

Apex® fastening tools, formerly part of Global Power Tools, will move into the newly formed Industrial Machined Solutions (IMS) Group. Providing consumables for power tools, Apex is a market leader of fastening tools such as bits, sockets, wrenches, and torque products that are engineered for the toughest industrial applications.

Product Families include: Utica®, Geta®, µ-Guard™, Universal Joints

Industry Focused Solutions

Our Global Power Tool brands of Cleco®, Cleco-Dotco® and Recoules Quackenbush® have been entrenched in the major vertical markets of Motor Vehicle and Aerospace. We also have a strong presence in general industry with key end-user brands. We continue to focus on general industry sub-verticals to gain deeper penetration.

We are global partners for global customers.





Motor Vehicle Industry Overview

Apex Global Power Tools has been pioneering innovations and solutions for the challenging applications and stringent requirements of the motor vehicle industry for decades. Our diverse product portfolio including DC electric and pneumatic tools contributes globally to all aspects of powertrain and final assembly for all sizes and types of vehicles including:

Light Passenger Vehicles



Class 4 – 8 Trucks



Tier 1 Components



Off-Road and Agriculture



Motorcycle and Recreational Vehicles



Global Motor Vehicle Customers

As a global solutions provider, we work with iconic global brands in the motor vehicle industry.

Audi
BMW
Cat
Case
Cummins
Daimler
Fiat Chrysler

Ford
General Motors
Harley-Davidson
John Deere
Lamborghini
Land Rover
Nissan

Peugeot
Peterbuilt
Porsche
Rolls Royce
Toyota
Volkswagen
Volvo



Aerospace Industry Overview

With sales of \$1.5 billion and international scope, and its 27 plants located on every continent, Apex Tool Group is one of the biggest professional manufacturers in the power tool world.

Apex Tool Group has a track record of providing tools to the global aerospace market that dates back to the 1940s. Many Apex Tool Group innovations from brands like Cleco®, Recoules Quackenbush®, Apex® and Dotco® are built specifically with the stringent standards of the aerospace technician in mind. They improve productivity and ensure strength and precision – attributes critical to the assembly process, where quality control technicians spend a great deal of time on inspection.

In partnership with the world's leading aircraft manufacturers, our drilling lines, screwing, riveting, and material removal tools, are constantly evolving to be more productive, and to have more precision, traceability, connectivity, and safety features.

Apex Tool Group also offers a unique competence in combining precision drilling tools and cutting tools. Beyond their high accuracy and quality, our tools (PCD, carbide, HSS) are associated with the highest levels of productivity. Our cutting tools also benefit from a resharpening service.

The biggest names in aerospace trust Apex Tool Group power tools for the assembly and finishing of their most critical aircraft, defense and space systems. These include:

Some of Our Global Aerospace Customers

Airbus

Aircelle

Boeing

Bell Helicopter

Cessna

Embraer

Hamilton Sundstrand

GE Aviation

Gulfstream

Hawker Beechcraft

Lockeed Martin

Northrop Grumman

Piper

Pratt & Whitney

Sikorsky





General Industry Overview

Industrial manufacturing requires consistency and precision when executing high-volume work. For over 100 years we have delivered the tools that perform every day. We are well positioned for continued aggressive growth in general industry. Every major manufacturing category relies on our tools including:



Small Equipment Assembly



HVAC & Pump Manufacturing



Primary Metal & Installation



Energy & Power Generation



Appliance Assembly



RV, Trailer Mobile Home Manufacturing



Rail, Bus, Heavy Equipment Manufacturing



Heavy Industry



Maintenance, Repair, Overhaul

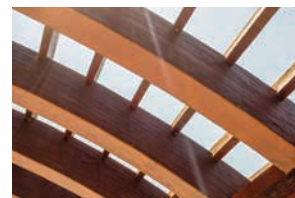

Furniture & Woodwork



Petrochemical



Marine & Shipbuilding

Some of our General Industry Customers

- Alcoa
- Cat Reman
- Carrier
- Exxon
- Frigidaire
- GE Energy
- Husqvarna
- John Deere

- Johnson Controls
- Lazboy
- Maytag
- Trane
- Trinity Rail
- Westinghouse
- Whirlpool



Product Overview for Vertical Markets

Our broad product portfolio of power tools provides our customers the flexibility to select the functions and results required within their specific vertical markets. Below is a breakout of the key benefits available:

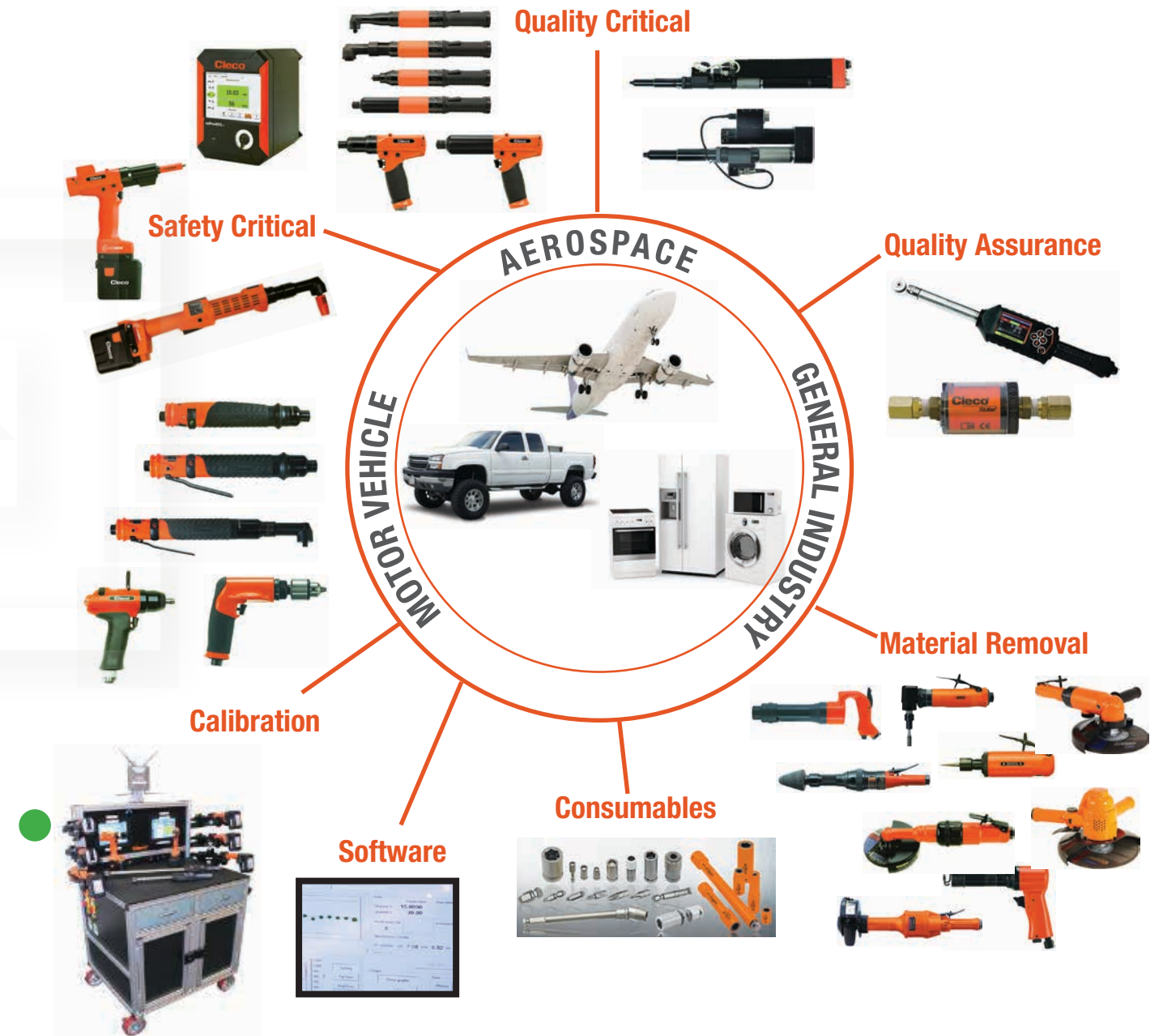



Global Power Tools General Safety



At Apex Tool Group, one of our core values is safety. We put a very strong emphasis on being an industry leader in offering power tools that incorporate ergonomic features and can be operated safely in multiple production applications related to material removal and assembly tools. We understand the critical role that safety plays in any manufacturing environment. The loss of people, not dollars, is the most tragic loss of all.

Safety From Noise

The cost of noise to industry is estimated to be in the billions of dollars annually. These dollars are lost through drops in efficiency and productivity associated with loud noise. And, fatigue and loss of communication in a noisy environment contribute substantially to accidents. The loss of people, not dollars, is the most tragic loss of all.

Years ago, Apex Tool Group took the lead in noise abatement with its newly developed rear exhaust grinders with overhoses. Thousands have been sold – many to users who did not really need additional or replacement grinders but wanted the benefits of the Cleco-Dotco[®] “whisper-quiet” grinders.

Cleco-Dotco[®] power tools have hundreds of “whisper-quiet” models with noise levels from 70 to 85 dBA. And of real importance to you, Cleco-Dotco[®] products have maintained their extremely high “power vs. weight” ratio for maximum productivity.

OSHA's Present Permissible Noise Exposure

A 3 dBA increase in noise represents a 100% increase (or doubling of sound energy).

Two identical air tools double the sound energy over that of one tool – a 3 dBA increase.

Two @ 80 dBA each = 83 dBA

Four @ 80 dBA each = 86 dBA

Eight @ 80 dBA each = 89 dBA

The above holds true if the tools are immediately adjacent to each other. Your customer is interested in the overall sound level where his employees are working.

Duration per day, hours	Sound level dBA slow response
8	90
6	92
4	95
3	97
2	100
1-1/2	102
1	105
1/2	110
1/4 or less	115
Proposed Changes	
16	80
8	85
4	90
2	95
1	100
1/2	105
1/4	110
1/8	115

You can see from this OSHA chart that a plant with a noise level of 93 dBA (which is not uncommon) has to take drastic steps to reduce this to 90 dBA, which means reducing sound energy by one half. This is where you can help the customer with Cleco-Dotco[®] products.

Safety Guards and Throttles

All abrasive wheels shall be used only on machines provided with Safety Guards

Section 4. ANSI B7.1 - 1970. safety code for the use, care and protection of abrasive wheels.

Wheel Guards

The requirement highlighted on the left does not apply to the following classes of wheels and conditions:

- Wheels used for internal grinding while inside the work being ground
- Mounted wheels used in portable operations, 2" in diameter and smaller
- Plug and cone wheels (types 16-17 – 18-18R - 19), where the work offers protection.

Written by the Grinding Wheel Institute, and later adopted by the American National Standards Institute (ANSI), the code, for the most part, is now incorporated in OSHA Regulations. This underlines the importance of proper wheel guards for use with abrasive wheels. Wheel guards, both straight and depressed center wheels, are listed in Cleco-Dotco® power tools product catalogs and should be used as required by the code.

Throttles

Cleco-Dotco® power tools keeps abreast of the latest information and is always trying to improve operator safety. Proper use of guards and throttles plays an important part in over-all plant safety – pointing out any discrepancies you see will help your customer promote safety on the job.

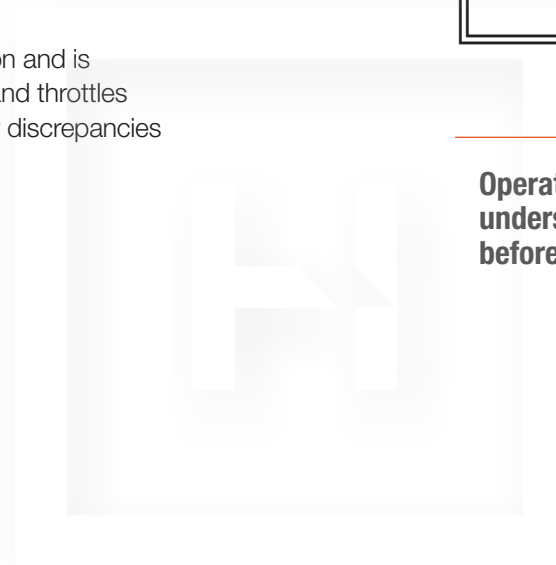

Safety Labels

The following are safety principles for our material removal tools as they appear in label form on our products.

Local safety rules and service instructions shall be followed.

Apex Tool Group includes safe operating instructions with all our power tools we ship globally.

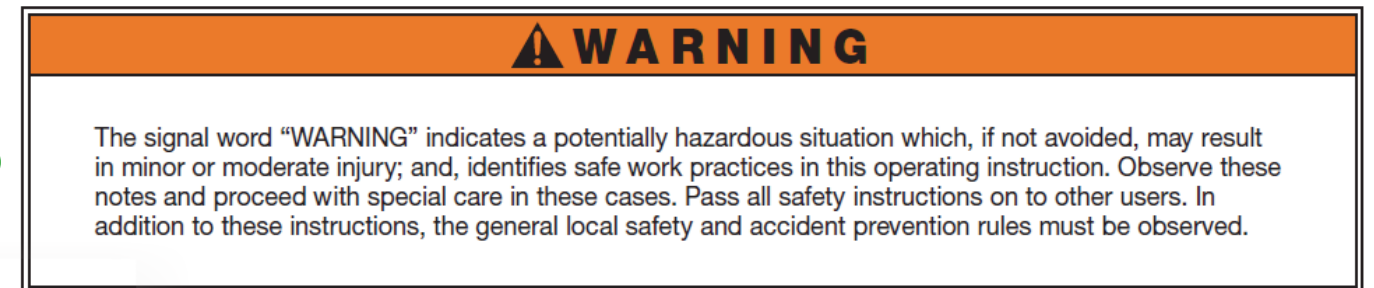

Operator shall read and understand product manuals before operating tool.

In addition to the separate safety instructions that are included with each new tool (for which we use bright red colored index size cards), we also highlight safe operating instructions in our individual product service manuals.

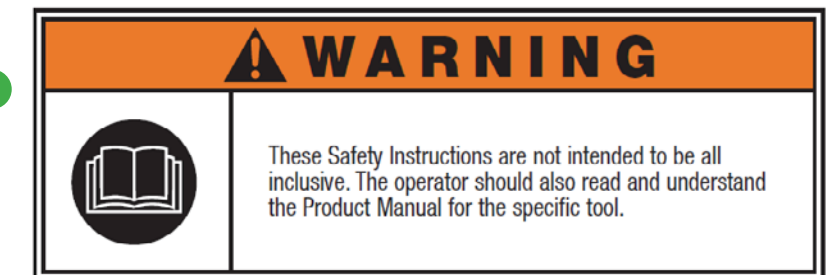

Dynamic line pressure shall not exceed 90 PSIG.

Apex Tool Group recommends that our pneumatic power tools be operated and tested at 90 PSIG max for their best performance and efficiency.

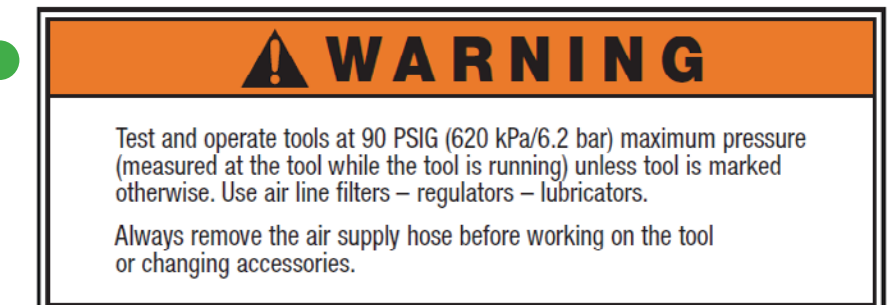

Check free speed of tool periodically to insure it doesn't exceed rated speed.

We recommend using either a hand-held or stationary digital tachometer to check the RPM (speed) on new, in use (governed tools every 20 hours of use), and repaired pneumatic power tools.

WARNING



Before mounting any abrasive wheel, buffing wheel, wire brush, saw blade, flap wheel or other product, after all tool repairs and whenever a tool is issued for use, the rpm should be checked with a tachometer to insure that its actual speed does not exceed rated speed. Governed tools in use on the job should be checked at least once every twenty hours of use, or once weekly, whichever is more frequent. Tachometers must be checked and calibrated on a regular basis according to the manufacturer's recommendations.

Tool shall not be used without guard. Guard shall be mounted correctly.

Any bonded abrasive grinding wheel over 2" in diameter should be used with a wheel guard to protect the tool's operator and those around him from the danger of grinding wheel breakage.

WARNING



Select proper guards for the application and mount securely and properly. Always mount guards so that abrasive debris, sparks, etc., are deflected away from the operator.

Safety guards should be in good condition. Any guard which has been subjected to a wheel failure should be discarded and replaced.

Abrasives shall be inspected on a regular basis.

Always inspect wheels, blades, and brushes for any visible damage before installation on the power tool.

WARNING

Regularly inspect all wheels, etc., and discard cracked, chipped, or otherwise damaged units.



Speed rating of abrasive shall be equal to or greater than free speed of tool.

Abrasive wheels (including flap, buffing, wire brushes) and saw blades should all have a max/not to exceed RPM clearly marked on the wheel's "blotter" or etched into the body of the blade or brush. Make sure that the power tool has an RPM rating that is equal or lower than the max/not to exceed speed rating of the abrasive to avoid the danger of wheel/blade failure.

WARNING



Speed rating of abrasive wheel, buffing wheel, wire brush, saw blade, flap wheel, or other products used, must equal or exceed speed rating of tool.

Exceeding the speed of accessories may cause failure of these products and serious operator injury.

Wheels must clearly show the rated speed for its use, or must be discarded and not used.

Proper mounting of abrasive shall be adhered to.

CAGI and ANSI standards must be adhered to when properly mounting wheels and blades on power tools. For example, in the case of a Type 1 wheel, this includes making sure that the inner and outer flanges are of equal diameter and relief, and that they cover a minimum of 25% of the total diameter of the wheel or blade.

WARNING

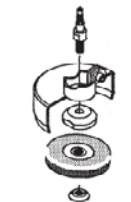

Each type of wheel, wire brush, saw blade, flap wheel, and other product, has specific mounting procedures and regulations concerning spindles, flanges, blotters, collets, etc., which should be used. Wheels must mount on tool's spindle freely but not loosely. Spindle nuts must be tightened so as not to crack the wheel with too much force. Nuts must have all thread engagement.

Hearing protection shall be worn as required by work environment.

Larger pneumatic power tools can sometimes have higher noise levels (dBA) that are intensified by the noise generated when the abrasive wheel contacts the work as the operator force feeds the tool. Hearing protection is highly recommended for these cases and others when the application generates over 90 dBA.

WARNING



High sound levels can cause permanent hearing loss. Use hearing protection as required by the work environment and grinding application.



Personal Protective Equipment (PPE) shall be worn while operating tools.

Proper safety glasses and or face shield, ear plugs, steel toe shoes are all examples of PPE that are typically worn when material removal tools are in use.



Pre-testing tool/abrasive mounting is a good work practice.

The above warning is especially true before demonstrating a grinder that uses a bonded abrasive wheel, mounted point, flap wheel, etc.

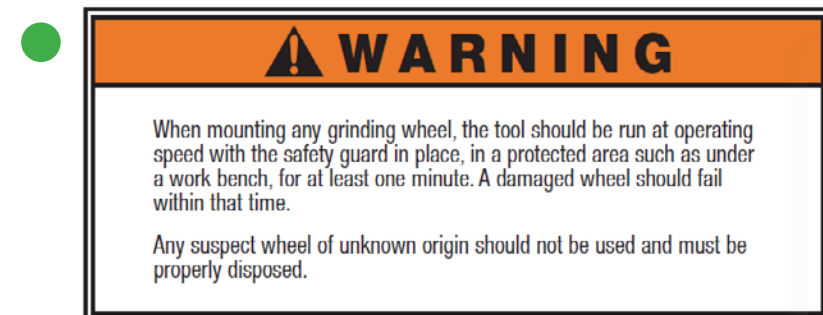

Pay attention to the tool and abrasive during operation.

Material removal tools are designed to minimize vibration. Excessive vibration or sound during or before operation may indicate a safety risk.

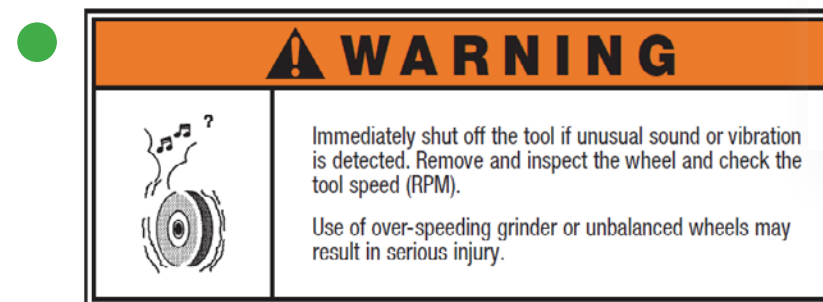

Safety programs are there to protect you. Follow them!

Examples of organizations that offer handouts on the safe operation of pneumatic include: The Compressed Air and Gas Institute ("CAGI"), ANSI and, NIOSH.



What are Cumulative Trauma Disorders?

Many traditional work injuries occur suddenly as a result of a specific incident. Cumulative Trauma Disorders (CTDs), on the other hand, develop gradually over a period of weeks, months, or even years. It is thought that this may be due to prolonged stress of a particular body part, often compounded by awkward body postures. For this reason, CTDs are frequently referred to as overuse or overexertion disorders.

Because of the extensive use of the hands, arms, wrists, and shoulders to perform manipulative work, CTDs frequently manifest themselves in these portions of the body. Although many symptoms are associated with CTDs, the most common are pain, restriction of joint movement, soft tissue swelling, and numbness of the extremities.

It is often difficult or impossible to distinguish between the occupational and non-occupational factors that contribute to developing CTDs. The disorder may be related to such common activities as gripping, twisting, reaching, and bending. What seems to create the hazard is not the activity itself but its chronic repetition in a forceful and awkward manner without rest or sufficient recovery time.

Examples of some of the more common CTDs are listed below. A qualified medical practitioner should evaluate employees complaining of any of these symptoms.

- *Carpal Tunnel Syndrome*
- *Tendinitis*
- *Tenosynovitis*
- *DeQuervain's Disease*
- *Trigger Finger*
- *Vibration Syndrome*

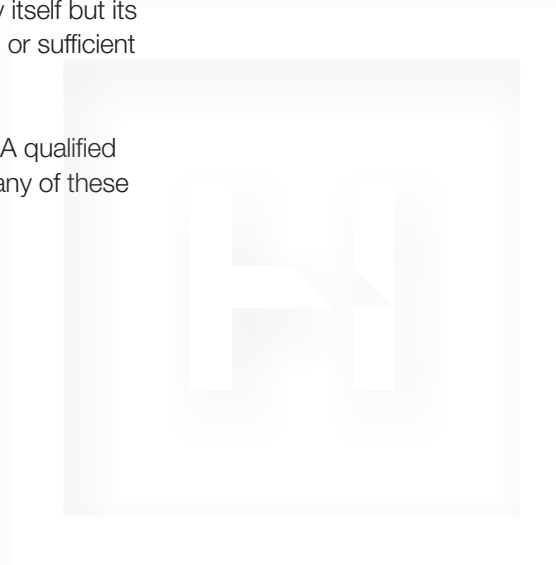

Cumulative Trauma Disorders Defined

Here we define Cumulative Trauma Disorders (CTDs), in more detail. Employees experiencing these symptoms should seek medical treatment to avoid the longer term disabilities these disorders can lead to.

Carpal Tunnel Syndrome

Caused by compression of the median nerve, which runs through the wrist. Early symptoms include numbness or tingling and burning sensations in the fingertips.



Tendinitis

The tendons of the hands and wrists can become sore and inflamed from stretching or constriction. Symptoms include pain, swelling, tenderness, and even redness of the hand or wrist.



Tenosynovitis

An inflammation of the sheaths surrounding the tendons, which may also lead to pain, tenderness, and swelling.



DeQuervain's Disease

A progressive constriction of the tendon sheath, which affects the tendons on the side of the wrist and at the base of the thumb. Symptoms include pain and difficulty in movement.



Trigger Finger

Results when the tendon sheath is sufficiently swollen so that the tendon becomes locked in the sheath. This will cause a snapping and jerking movement when attempting to move the finger.



Vibration Syndrome

Also referred to as white finger or Raynaud's phenomenon. The disorder is often associated with the prolonged use of vibrating tools, especially in cold weather. It is characterized by recurrent episodes of finger blanching.



Ergonomic Areas of Concern

Noise

This area has been highly visible for a number of years. OSHA and ISO have been leaders in establishing allowable levels of noise (measured in decibels) and the acceptable duration of exposure at those levels. In some instances, private corporations have established their own standards.

It is reasonably easy to test air tools for noise output. Dotco Power Tools does this testing, and all new designs must fall within their specifications.

This is one instance where management at the work place must step in, however, and test the noise level at the worker's ear. Many processes generate noise levels much above the output of the tool due to the interaction of the tool and the work place. For instance, a very quiet grinder may make a lot of noise when the wheel grinds on a large sheet of steel.

Dotco power tools' new ergo drill produces only 80 dBA – a full 10 dBA below recognized safe standards.

Torque Reaction

While no government standards have been established for this area, some guidelines have been developed. It is commonly accepted that 100 inch pounds is the maximum torque that should be delivered by a pistol grip tool. Cleco-Dotco® power tools provides “bucking bars” in a number of different configurations, which can be applied to their nutrunners to transfer the reaction torque to stationary “bucking points” on the product. Also, reaction-absorbing mountings are available to both support the tool in a convenient position and transfer its reaction to a solid structure; thus relieving the operator of both tool weight and reaction.

On larger shutoff-type nutrunners, the inertia of the tool helps absorb reaction torque, especially with fast rundown when coupled to a quick release clutch. This time/torque reaction “curve” becomes very beneficial to the operator on “hard” joints, and less so when a long draw down is experienced.

Impact and impulse tools make it possible to generate very high torques with minimum reaction on the operator. They do this by using a heavy rotary hammer that automatically delivers a rotary blow to an “anvil” that carries the socket either directly – metal to metal – or through a hydraulic cushion. This way the only reaction the operator feels is associated with the rotary accumulation of the hammer over possibly 360 degrees of rotation; at which time it engages the “anvil” substantially isolated from the operator.

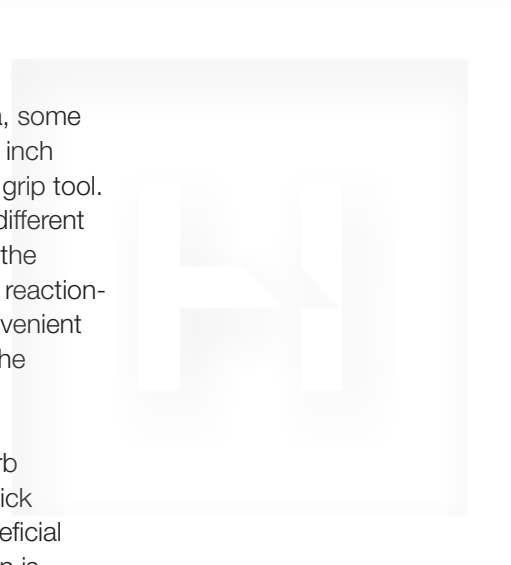

Ergonomic Areas of Concern cont.

Vibration

This is an area that is very difficult to qualify although many studies have been conducted to try and find acceptable limits of frequency and amplitude. ISO paper #5349 puts forth recommendations but due to the complexity of the subject these recommendations are only useful as a guide.

Suffice it to say, extreme vibration can cause vascular injury in fingers, and damage nerves, bones, and joints – so it should be held to a minimum.

In an attempt to minimize vibration, grinders should always have wheels that are in dynamic balance and are running true. If not, the wheel should be replaced or trued on the spindle.

Small, high frequency die grinders can be sheathed in absorbent sleeves or built with isolated motors that are cushioned from the outer housing.

Large grinders can have handles with vibration dampers at the attachment point or the handles can be sheathed with absorbent materials.

In the case of handle exhaust tools, the cushioning material also acts to insulate the handle, which is cooled by the exhaust air.

While impact and impulse tools are not inherently high vibration products, it is important to keep sockets and wire extensions from becoming worn and sloppy. The product also needs to be firmly held or nested and have a straight drive line to keep from reflecting the impact back onto the operator.

Dust

The very fine dust particles generated by grinding are the most troublesome. They tend to float in the air and can reach the lungs. However, they do not “fly across the room” like the spark showers of the much larger visible particles.

A rotary shield attached to an appropriate vacuum source has a good chance of capturing most of these particles. Ideally the workstation should have its own hood that will capture all of the particles produced by the grinder and suction it away.

A permanent, high vacuum exhaust system serving the workstation or a tool-mounted collector is by far the most efficient system. Self-contained systems using tool exhaust to generate vacuum do not have the vacuum pull of a properly setup and maintained permanent exhaust system but are certainly better than nothing.

Drilling machines can be fitted with telescoping noses attached to a vacuum source to remove drilling swarf and coolant (if it is used). These are common in aerospace work where graphite, Kevlar and fiberglass are frequently drilled producing very abrasive dust, and where coolant is often introduced to facilitate drilling the more difficult materials.

Ergonomics as it Applies to Cleco-Dotco®

On this page, we'll look at how Cleco-Dotco® power tools and top biomechanics experts perfected ergonomics including:

Comfort Design

- Rounded surfaces
- Handle sizes to fit the worker's hands
- Large surface area for pushing on pistol grip drill
- Reduced trigger force to reduce operator fatigue
- Handle size and length to accommodate entire hand
- High power to weight ratio reduces operator fatigue
- Hand position on handle keeps all digits in the most natural position
- No pinch points

Environment

- Oil-less rotor blades
- How the product is applied to the work
- Handle orientation with respect to the worker's position

Vibration

- Output spindle concentricity:
grinders – + .001, drills – + .002 (1" away from chuck)
- Caged planetary gears
- Pre-load output ball bearings
- Complete ball bearing support

Noise

- Noise levels maintained at least 10 dba below required standards (OSHA)
- Drills = 77 - 80 dba, Grinders = 80 dba

Temperature

- Front exhaust tool reduces cold temperatures transmitted to the hand
- Polymer coatings and insulation tubes are used on rear exhaust tools

Example of a Drill Ergonomic Improvements

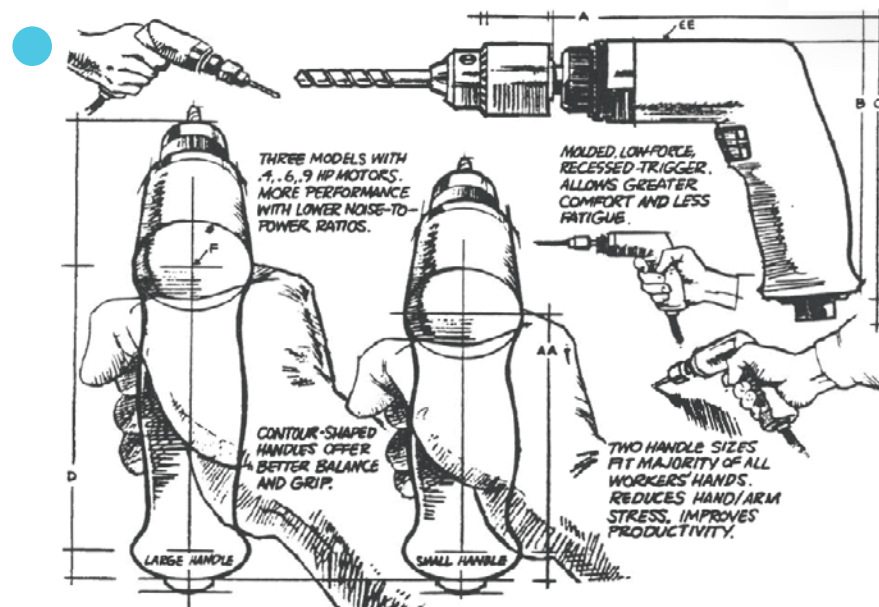

HERMES
TOOLS



How Pneumatic Tools Work



HERMES
TOOLS

Basics of Pneumatic Tools

There are two primary sources that drive hand-held industrial power tools: DC electric (including cordless) and air or pneumatic powered by compressed air supplied by a gas compressor. Even though Apex Tool Group's portfolio includes both configurations of power tools, we're going to focus this section of our training program on all aspects of pneumatic power tools.

There is a widespread application of small pneumatic motors in hand-held tools like drills, Sanders, grinders, and saws. Even though overall energy efficiency of pneumatic tools is low and they require access to a compressed-air source, there are several advantages over electric tools.

Pneumatic Advantages

Pneumatic tools offer greater power to weight ratios – as a smaller pneumatic motor can provide the same amount of power as a larger electric motor. They also do not require an auxiliary speed controller, which adds to their compactness and generate less heat. They can be used in more volatile work atmospheres because do not require electric power.

In terms of use and maintenance over time, pneumatic offers the advantages of generally being cheaper, safer, and easier to maintain than electric power tool counterparts. Some drawbacks for pneumatics include the need for a compressor system and associated equipment to operate. Pneumatic tools can be more expensive in the initial purchase and require more regular lubrication and maintenance. Pneumatics are viewed as less environmentally friendly.

Sampling of Cleco-Dotco® Pneumatic Tools



HERMES
TOOLS

Cleco
DOTCO

Compressed Air Systems - Basic Terminology

The following discussion will give you an understanding of the terms used when talking about compressed air.

Air Pressure - Pounds Per Square Inch (PSI)

An air compressor can be compared to a generator producing electricity. Pounds per square inch (PSI) of pressure produced by an air compressor are comparable to voltage produced by a generator.

The size of a generator does not determine the voltage it can generate – a small generator can produce 115 volts as easily as a large one; however, the small generator will have a lower load carrying capacity. The same is true for air compressors; small units will produce just as many pounds of pressure as larger units, but they will not be able to deliver as much volume of air as the larger units.

In most industrial applications, compressors are set at pressures varying from 90 psi to 120 PSI at the receiver or storage tank. All compressors have a device that automatically maintains air pressure between two preset limits, for example, between 105 and 120 PSI. However, if the volume of air being used in the system exceeds the capacity of the compressor, it will not be able to maintain the pre-set pressure.

Air Consumption - Cubic Feet Per Minute (CFM)

All air-operated equipment consumes a certain volume of air during its period of operation. The amount or volume of air used is measured by the number of cubic feet of air displaced per minute at a given pressure. For example, the Model 10LI000A-36 grinder consumes a maximum of 12.0 CFM, when a pressure of 90 PSI is maintained at the tool while operating. It's similar to saying that an electric tool consumes so many amperes at a given voltage.

Air Compressor Capacity

The average electric motor-driven air compressor, as generally used in industry, will deliver between 4 and 5 CFM of air continuously per horsepower. For example, a 20 HP compressor will continuously deliver between 80 and 100 CFM. Large compressors may deliver over 5 CFM per horsepower. An old or worn compressor will in most cases deliver somewhat less.

Often, air consumed by a wide variety of uses will be greater than that required for portable tools. These other uses include paint spray equipment, air operated chucks, hoists, sandblasters, presses, and indexers.

Air tools are seldom operating more than 40% of the total time. There may be periods of short duration when a big percentage of the total tools are operating, but usually the receiver or storage tank will have sufficient reserve capacity to take care of the short overload.

HERMES
TOOLS

Cleco
DOTCO

Pneumatic System Infrastructure

A typical compressed air delivery system starts with a compressor that is rated by the amount of horsepower (HP) it is capable of generating. Additionally, an industry “rule of thumb” says for every 1HP of compressor rating, a generation of (5) SCFM is produced. So for a continuous operating tool that consumes 20 SCFM you would need 4HP in compressor rating.

Power output, speed, and air consumption of Cleco-Dotco® pneumatic tools are measured with an air pressure of 90 PSI at the tool and with the tool operating. Static pressure is the pressure measured in an air line when no air is flowing, and is always greater than the pressure measured under conditions of airflow. The amount of restriction in the air lines and the volume of air being used determine the difference in static pressure readings and those readings taken with air flowing. The difference in these readings is known as the pressure drop.

Typical Pneumatic Line Installation

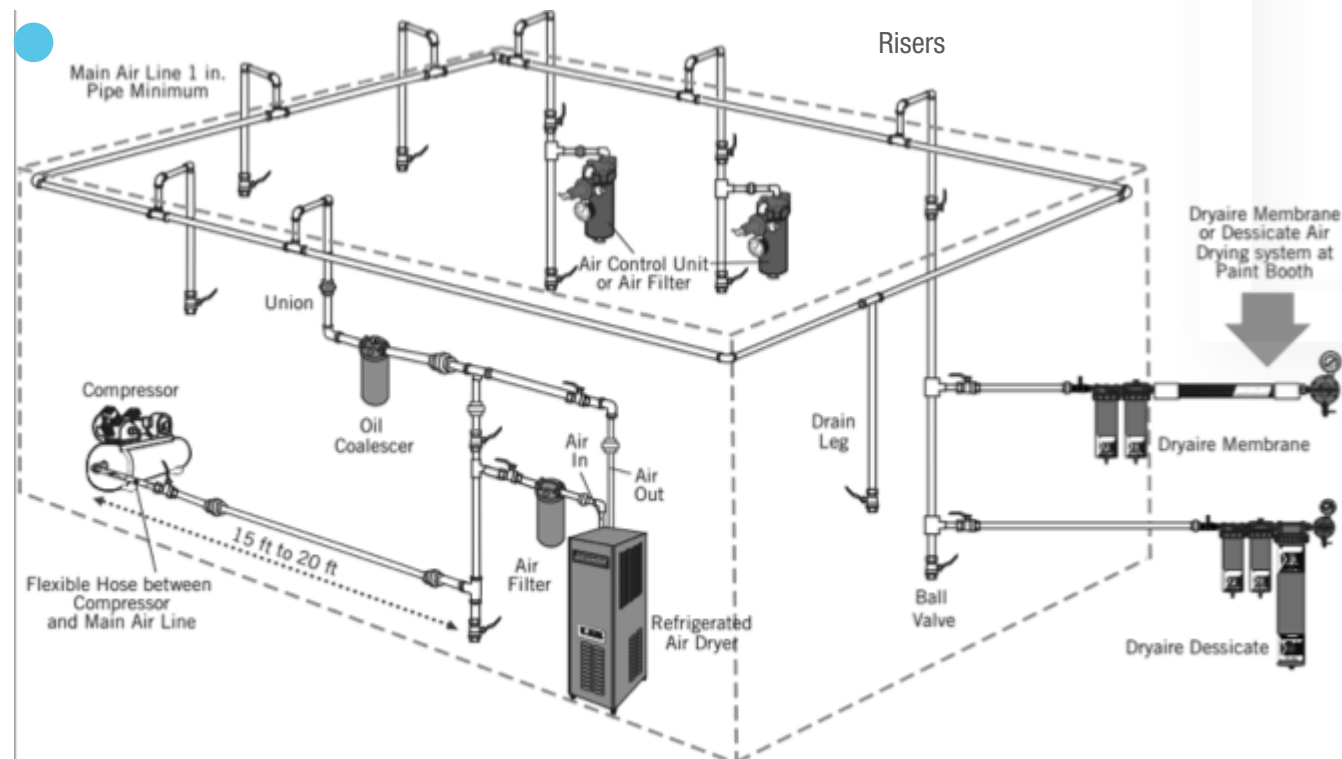

Pneumatic Systems

Air Pressure Drops

Excessive pressure drop is the most common cause of complaints involving loss of power in portable air tools. When such a complaint arises, be sure that someone takes a pressure reading at the tool while the tool is turned on – and governed tools while under load.

The most common causes of excessive pressure drop are restrictions to air flow in long lengths of small diameter pipes and hoses, hose fittings, filters, lubricators, and especially in quick disconnect couplings. For large volumes of air, large lines and fittings are required. Refer to pressure drop charts below and on page 42.

Air Pressure Loss (PSI) In Standard Cleco-Dotco® Power Tools Hoses (Includes loss through standard fittings)

Air Flow CFM	Pressure Loss (PSI) – Based on 90 psi Line Pressure					
	Hose Number and Size					
	1/4"x8'	5/16"x8'	3/8"x10'	3/8"x20'	1/2"x12'	1/2"x25'
10	3	2	1	1		
11	4	2	1	1.5		
12	5	2	2	2		
13	5.5	2.5	2	3		
14	6	2.5	2	3		
15	6.5	2.5	2	4	0	0
16	7.5	3	2.5	4.5		
18	9	3.5	3	5		
20	12	4	3.7	6	.1	.3
25	18	5.5	6	7.5	.7	.8
30	28	8	8.5	10.5	1.8	1.0
35	44	11	10	15	1.2	1.6
40		13	14	19.7	2.2	2.5
50		22	21.5	28.5	3	3.4
60		33	33	45	3.2	4

Note: Refer to the accessories section of the Dotco catalog for whiphose numbers.

Pneumatic Systems cont.

Air Pressure Loss (PSI) In 100 Ft. Of Steel Pipe *
(Based on 100 PSI at pipe entrance)

CFM of Free Air	Pressure Loss (PSI)							
	Nominal Pipe Diameter							
	1/2	3/4	1	1-1/4	1-1/2	2	2-1/2	3
10	0.40	0.10	0.03	0.007				
20	1.40	0.35	0.10	0.026	0.012			
30	3.15	0.70	0.25	0.056	0.026			
40	5.50	1.30	0.40	0.096	0.044			
50	8.60	2.00	0.60	0.146	0.067	0.200	0.008	
60		2.80	0.85	0.210	0.095	0.027	0.011	
70		3.80	1.10	0.280	0.130	0.036	0.015	
80		5.00	1.40	0.360	0.160	0.046	0.019	
90		6.40	1.85	0.450	0.200	0.058	0.024	
100		7.80	2.20	0.550	0.250	0.069	0.029	0.010
125		12.50	3.40	0.850	0.380	0.107	0.043	0.015
150		18.00	4.90	1.200	0.540	0.150	0.061	0.021
175			6.80	1.640	0.730	0.200	0.081	0.028
200			8.80	2.120	0.950	0.260	0.105	0.036
250				3.300	1.480	0.400	0.160	0.054
300				4.710	2.100	0.570	0.230	0.075
350				6.450	2.860	0.770	0.310	0.101
400				8.300	3.700	0.990	0.400	0.131
450					4.650	1.270	0.500	0.165
500					5.790	1.560	0.620	0.200
600						2.230	0.890	0.290
700						3.000	1.180	0.390
800						4.000	2.540	0.500
900						5.050	1.950	0.630
1000						6.200	2.370	0.780
1200						9.050	3.450	1.120
1500						14.500	5.390	1.730
2000							9.660	3.090
2500								4.850
3000								6.980

* Note: For longer or shorter lengths the pressure loss is proportional, i.e., for 50 feet use 1/2 of above values or for 200 feet use 2 times the above values.



Pneumatic Systems cont.

Operation and User Chart

This chart shows the basic operations performed in verticle industries with pneumatic tool functions.

Basic Operations Performed in Industry		Basic Industries	Operations Performed
1. Die & Mold Work	Barbering	Auto Assembly	2-5-6
	Beveling	Auto Assembly	4-5
	Blending	Auto Stamping	1-2-5
2. Fabrication	Drilling	Aerospace & Aircraft	1-2-4-5-7
	Hole Grinding	Building Prefab	1-2-3-6-7
	Surface Finish	Chemical	2-5-6
	Sawing	Construction	2-5
	Slotting	Die Shops	1-2-4-5
3. Foundrywork	Pattern Shop	Electronics	1-2-4-5-7
	Snagging	Fabricators: Metal & Plastic	1-2-4-5-6
4. Machining	Reaming	Forge Shops	1-2-4-5
	Slotting	Foundries: Ferrous, Non-ferrous & Die Casting	1-3-4-5
	Surface Preparation	Glass	1-2-3-5
	Tapping	Machine Builders	1-2-3-4-5-6
5. Maintenance	Die Repair	Machine Shops	4-5
	Sawing or Cut Off	Ordinance	1-2-3-4-5
	Surface Preparation	Refineries	2-5
6. Mixing	Weld Removal	Rubber	1-2-4-5-6
	Paint Stirring	Shipbuilders	1-2-3-4-5-6
7. Woodworking	Texturing	Transportation Equipment	1-2-3-4-5-6-7
	Sawing	Utilities	2-5-6
	Surface Preparation	Woodworking	4-6-7



5 Key Considerations When Selling Pneumatic Tools



When selling pneumatic material removal tools, the end user application used in conjunction with the required abrasive or cutter should be taken into consideration when selecting a solution. These include:

1. Application

First, focus on the customer's task at-hand and ask questions relating to the big picture application for pneumatic tools such as:

- *What are the business priorities for the pneumatic tool application?*
- *What is the target throughput being sought?*
- *What pain points are being experienced?*
- *Are there special requirements involved?*
- *What limitations are to be factored in?*

An example to consider is the needs involved in heavy weld grinding and drilling 1/8" holes.

2. Operator/Usage Environment

Look at the operator needs as well as where the application is executed:

- *Is the operating environment a good match for pneumatic tools?*
- *Are tool throwaway vs. repair a factor?*
- *What PPE is needed?*
- *Is an air infrastructure available and viable?*
- *Are operator needs and skill a good match?*

Think about outdoor and abusive environments the tool needs to function in like shipyards or aerospace parts suppliers.

3. Consumables

Consider the consumables used in conjunction with the tools for the application including:

- *Use of current drill bits, sockets, abrasives, bits, pads, sand paper, etc.*
- *Is there room for improvement?*
- *Are there opportunities to present total solution?*

Examples of industry-leading consumables include our 9" Type 27 Grinding Wheel or our HSS aircraft-grade drill bits. Both offer exceptional value.

4. Business Climate

It is a good idea to focus on the state of the business and the customer performance. Factors to consider:

- *What tools are currently being used?*
- *What is the state of overall economy?*
- *What is the economy of the specific industry?*
- *What is the future outlook and strategy to meet business goals?*
- *Are there preferred distributor(s) involved?*
- *What is the customer's tool purchasing pattern and is it a good match?*

For example, a thriving business will make decisions on value versus just price. Review if they are currently using "value" tools in their operations.

5. The Right Tool

The final component is to provide the end user with the correct tool to meet these considerations.



HERMES
TOOLS

Common Pneumatic Tool Brands

The air tool market is not lacking for differing brands and types. A generally accepted theory is there are essentially three grades of air tools in terms of the **quality, durability, and ergonomics**.

1. Industrial Production

Capable pneumatic tools offer the highest level of quality to achieve all three of the above benefits. They are durable and built for continuous use.

2. Value Focused Air Tools

These mid-range tools may be present in an industrial environment but are not necessarily designed for continuous use.

3. Consumer/Automotive Aftermarket Tools

These tools are used for short duration jobs in auto repair shops, home use, and others.

Below is a further breakout of brands in the three categories:

Industrial

Apex Tool Group:

Cleco-Dotco, Cleco, MasterPower

Atlas Copco Group:

Chicago Pneumatic, Desoutter, Georges Renault, Fuji

Other US Players:

Ingersal Rand, 3M, Sioux, Dynabrade, Top Cat, ATSCO, Florida Pneumatic/Universal Tool, ATA, ASG, Henry Tool, Michigan Pneumatic

Japanese Manufacturers/Brands:

Uryu, Toku, Yokota, Koken, Kuken, Nitto Kohki

European Brands:

Fiam, Deprag, Mannesmann Demag

Automotive Aftermarket

Brands include:

Mac, Matco, Cornwell, Snap On, IR, NAPA, AirCat, Rodcraft, Hazet, Wurth, Beta

Big Box, Chain Stores, DIY

Consumer recognized brands include:

Craftsman, Husky, Kobalt, Northern Tool, Campbell Hausfeld, Central Pneumatic

HERMES
TOOLS

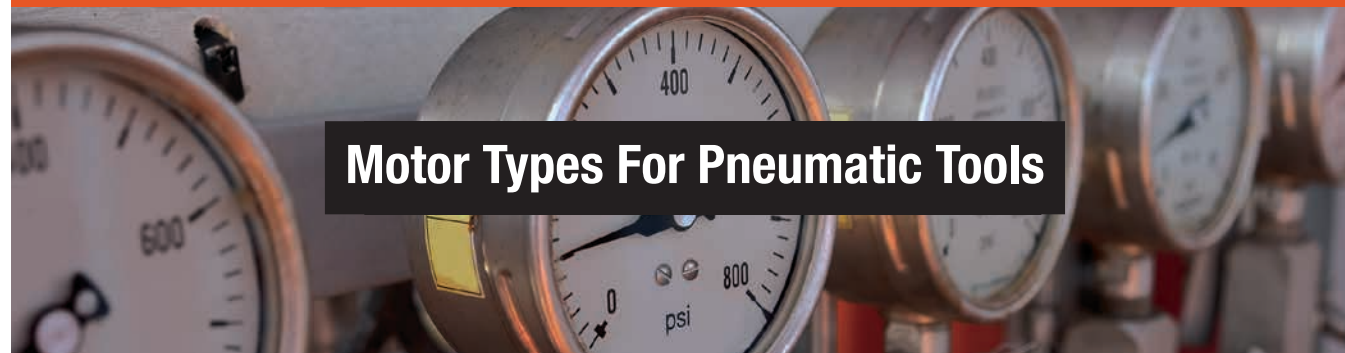

Motor Types For Pneumatic Tools

There are different types of pneumatic motors that are used in conjunction with certain tool functions. On the following pages we will look at the different motors including rotary vane, linear piston, and percussion tools.

Rotary Vane Motor

The rotary vane motor is the most common air motor used in pneumatic tools. It uses compressed air to produce rotational motion to a shaft. The rotating element is a slotted rotor fitted with freely sliding air “vanes”.

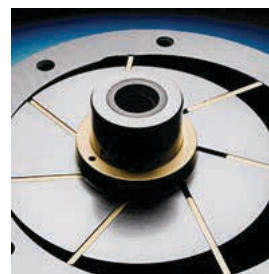

The old metaphor that the air motor operates like a “windmill in a tin can” can give a general idea to someone just beginning to explore how a pneumatic motor generates speed and power. Air motors vary in size and in the number of rotor blades used to establish their speed and power (HP). They need clean, dry and lubricated compressed air for optimum operation.

Rotary vane motor driven tools include:

- Air impact wrench
- Air ratchet wrench
- Die grinder, angle grinder, vertical grinder
- Sanders, polishers, buffers
- Drills
- Screwdrivers and nutrunners
- Cut-off tool, circular saws, cutters

Rotary Vane Motor Tool Examples



HERMES
TOOLS

Rotary Vane Motor Operation

The diagram below further breaks down the basic rotary vane motor function offered in Cleco-Dotco® tool motor functions.

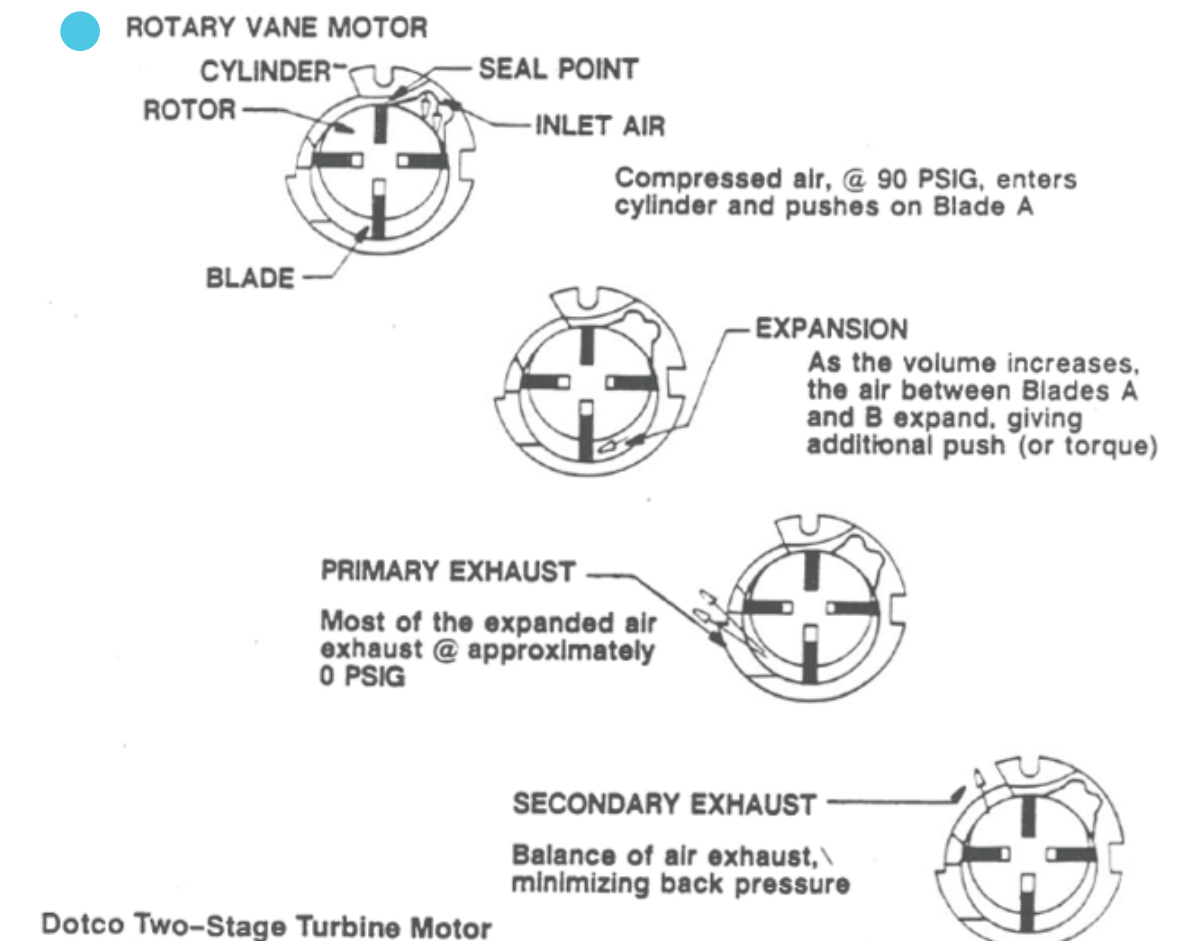

Dotco Two-Stage Turbine Motor

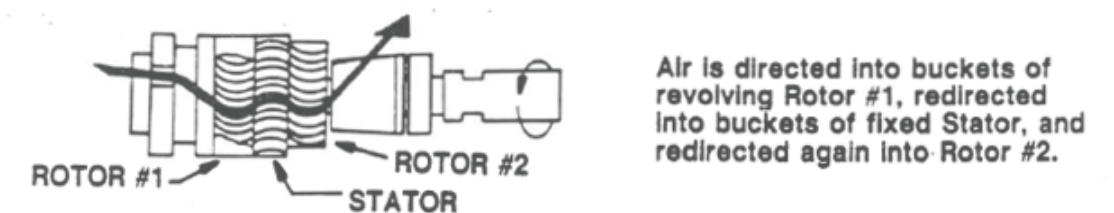

HERMES
TOOLS

Linear Piston Motor

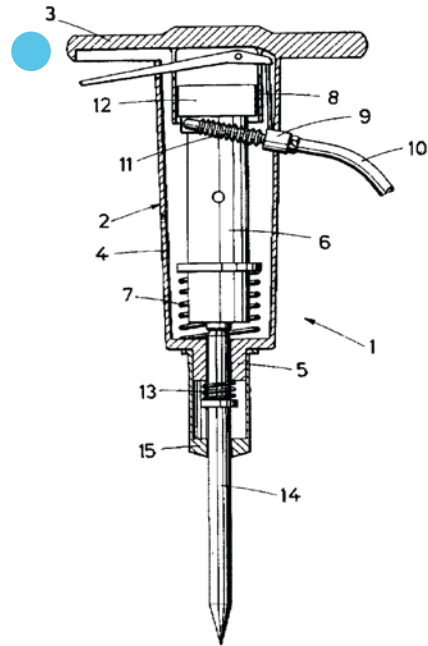

The linear piston motor is popular with tools that need linear motion instead of rotary motion.

Linear piston motors use an air-tight chamber to house the shaft of the piston. Timing and the surface of the piston is used to direct air into the chamber where a spring or (air cushion) is used to drive or “shuttle” the piston back-and-forth inside the chamber, causing a “percussion” effect. Linear piston motors are what drives what is commonly called Percussion Tools.

A jack hammer (left) is a common percussion tool that uses this linear power motion although the technology can convert into smaller hand-held tools.

Percussion Tools

For demolition type tools like rammers and hammers, the back and forth motion (percussion) allows for breaking concrete, tamping down asphalt, and a number of other construction-based applications. Saws also have the ability to cut construction type materials. Scalers are popular for rust and weld removal. Rivet hammers are used in a number of aircraft applications to join components together using rivets as fasteners.

Some examples of percussion tools include:

- Pneumatic and riveting hammers
- Chipping hammers and chippers
- Scalers (piston, rust, weld, needle)
- Rammers and tampers
- Inline piston sanders
- Reciprocating saws
- Jackhammers
- Pavement breakers



HERMES
TOOLS

Cleco
DOTCO®

Other Pneumatic Tools

Air Turbine Motors

Air turbine motors use a stator and an impeller in the same fashion that aircraft jet engines do and require no lubrication. They can be very effective in areas where no lubrication is available and where higher RPM's are needed. An example of this is tools used in a clean room environment.

Some examples of air turbine motors used in rotary tools include:

- Turbine angle grinder
- Precision turbine high-speed grinder
- High speed turbine spindles
- Dental handpiece tools



Motorless Devices

Motorless devices control incoming air through the use of a valve that delivers air to a target. They also use the incoming air to apply a substance (in most cases paint) to a surface.

Some examples of motorless devices include:

- Paint sprayer
- Sandblaster
- Blow gun
- Venturi vacuum



HERMES
TOOLS

Cleco
DOTCO®

Commonalities of all Pneumatic Tools

Let's look at what all airpower tools have in common. The air motor design has a free speed that when connected to planetary gearing and angle gearing (bevel and pinion type gears in right angle tools) drops to a slower RPM and increases the tool's torque.

Almost all air-powered tools have the following in common, no matter the tool type, application or design:

- Air inlet and exhaust**
- Handle**
- Actuation (on/off)**
- Motor and motor housing**
- Transmission or drivetrain**
- Output to connect or attach to consumables**



HERMES
TOOLS

Motor Power to Tool Configurations

To transfer motor power to the work at the right speed and torque and in a more usable configuration, use:

Non-Geared, Non-Governed motors to give highest speeds for material removal with carbide burs or mounted wheels. Normally used for cutting tools under 2" in diameter.



Governed motors for operation at specific controlled speeds for safety with grinding wheels, brushes, and flap wheels. As the tool is put under load, the governor opens to admit more air to maintain speed for maximum power. So in addition to its speed control function, the governor also saves air. A minimum amount of air is used until the tool is put under load. The air consumption increases with the load on the spindle.



Planetary-gear motors to provide lower speeds and increased torque for proper drilling, buffing, and other reduced speed operations.

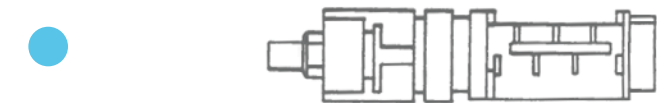

Right angle motors for ease of use with sanding discs and pads. In many models, the combination of governed or planetary-gear motors, along with the angle gear reductions, produce the proper speeds and torque for grinding, sanding, buffing, polishing, wire brushing, reaming, and drilling. Right angle tools have a low profile and are useful for getting into hard-to-reach or confined areas.

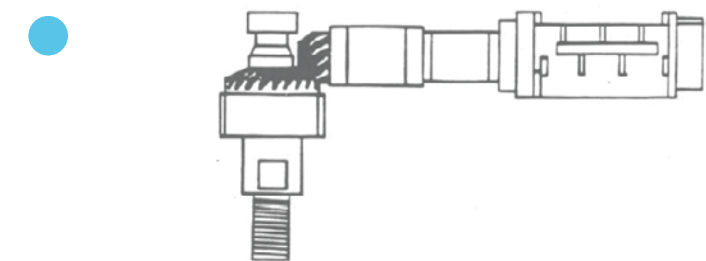

HERMES
TOOLS

Commonalities in Different Pneumatic Tool Configurations

Different handle/housing configurations are offered to improve ergonomics, access to the job, and mounting to a fixture. For example, one common pneumatic motor using the same pneumatic motor parts can be configured with either a pistol, in-line, right angle, 30 or 45 degree offset or even a fixture housing.

Different configuration pneumatic-powered tools have the following in common, no matter the tool type, application or design:

- Air inlet and exhaust**
- Handle**
- Actuation (on/off)**
- Motor and motor housing**
- Transmission or drivetrain**
- Output to connect or attach to consumables**

Pistol-grip Configuration



In-line Configuration



Interesting Pneumatic Tool Facts

As we wrap up this section on how pneumatic tools work, here are some interesting facts:

- A majority of pneumatic tools and parts (by volume) are manufactured in Asia, especially China, Taiwan, and Japan. Even tools declared "Assembled in USA" contain parts predominantly made in Asia.
- The minimum recommended hose ID is almost always 1/8" larger in diameter than the tool's air inlet (1/4" inlet -> 3/8" Hose ID; 3/8" Inlet -> 1/2" Hose ID).
- The grease and oil used on the tool can have a large impact on its performance and lifespan. Consult the manufacturer for recommendations.
- Most angle gears/right angle tools recommend that the gears be greased at least once every 8 hours of operation.
- Many Cleco-Dotco® right angle tools include a "wick system" where a lubricator disc rides on the tool's spindle, above the bevel gear. The wick absorbs grease and improves the bevel gear lubrication (vs. grease being leaked out of the angle head's interior).
- There is no standardized way to test or declare the output torque for an impact wrench.
- One of the toughest elements to design and manufacture in a pneumatic tool is the angle head. Any tool with an angle head will have reduced life compared to an in-line counterpart.
- Older Cleco-Dotco® right angle tools that use the 1066/1067 or 1188/1187 gear sets need to be shimmed for best gear engagement (or lash).
- Newer Cleco-Dotco® right angle tools (like the 10LF/12LF series) do not need to be shimmed for best performance.
- When an air tool is "bogged" down by grease, grime, and air particulates in the line, PB Blaster and PB Blaster Air Tool Conditioner can effectively increase the tool's performance.
- Pneumatic principles apply to weapons, automobiles, aviation, and many other industries.
- Maximum output power occurs at 1/2 of the free speed.
- "Gearing" a tool reduces the rotational speed but adds torque or the "twisting force."
- Certain air tools are mounted to large construction vehicles for mining or quarrying.



Introduction to Material Removal



Overview

In this section, we will cover the basics of material removal and the pneumatic power tools required for the job. We intend the information to be a practical guide with emphasis on the three basic material removal tasks and the specific applications of each, where applicable.

1. Grinding and sanding including terminology, applications, consumables, applicable industries and Cleco-Dotco[®] tool products as they relate to the three primary tasks of:

- Precision (die) grinding and deburring
- Rough grinding and cutting off
- Sanding and polishing

2. Drilling including applications, common consumables, drill bits, applicable industries, and Cleco-Dotco[®] tool products.

3. Percussive material removal with safety precautions, applications, consumables, applicable industries and Dotco tool products.

The subject of material removal is very complex and difficult to define since it covers so many overlapping areas. There are a large variety of materials to consider, operations to fit within, and target results to achieve. This is why there are so many different tools with a huge selection of rotational speeds, types, and shapes of abrasives and other consumables.

What is the main purpose or desired result of the material removal operation?

We start by asking a wider question: What is the main purpose or desired result of the material removal operation?

With the combinations of all the material removal tasks, tool types, and abrasives to consider, the three tasks identified above provide the simplest method of categorizing. We can make clear distinctions between applications in reference to target results, purpose, tool types, abrasives, settings or techniques.

We will explore these in depth on the following pages.

Terminology

Before delving into the overview of material removal tools, let's review some key terms and definitions that we will be used throughout this section.

Torque

Torque is the force applied at the end of a lever or the force applied in a turning direction. It is the product of the force and the distance (radius) from the axis of rotation. Torque is measured in Newton-meter (N.m), inch per pound (in.lb), and foot per pound (ft.lb).

Power

Power is the product of torque and rotational speed. It is defined by energy per time unit; measured in HP, kW.

Note: Torque is inversely and directly proportional to power. As speed increases, torque decreases proportionally (for non-governed tools).

Illustration of Torque

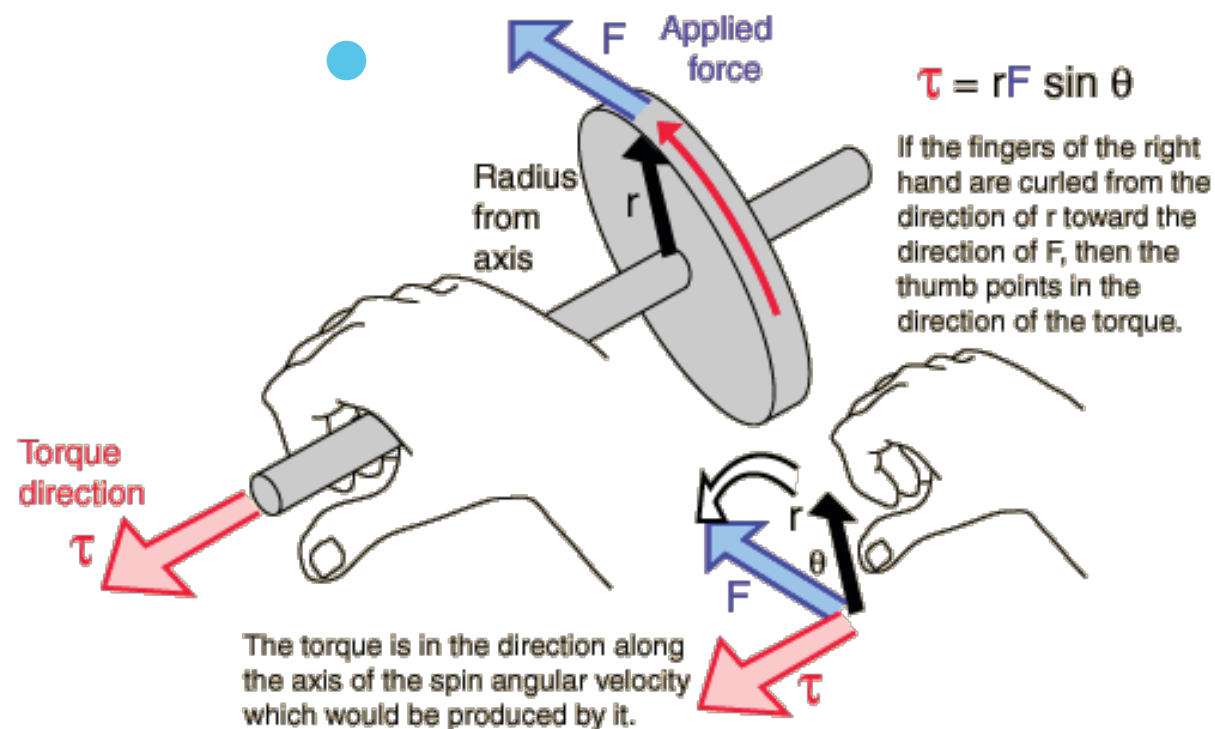

Terminology cont.

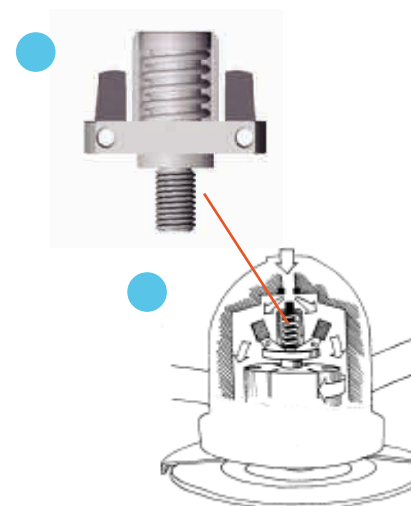

Traditional Governor

The long proven construction is with two pendulums. The pendulums extend due to centrifugal force and block intake, also the springs adjust pendulums by retraction to control free speed. However, the free speed can not be controlled effectively within standard RPM when air pressure increases.



Feed Force

Feed force is the amount of pressure exerted on the tool by the operator during operation. Beyond the tool's power, excessive load or feed force can be inefficient and dangerous.

For example, when the cutting device (abrasive, drill bit, sand paper or other consumables used in material removal) is applied to the work piece the rotational speed decreases as the cutting device is held back by the torque. This is caused by the rotational action and the feed force. The higher the feed force, the lower the rotational speed.

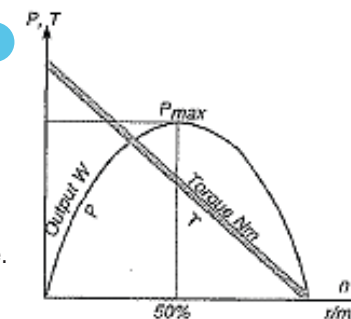

With a non-governed tool, maximum power is generated at 50% of the maximum rotational speed (RPM).

Governor

A governor is a device equipped in between the inlet and the motor to limit air flow through the motor when no load torque is applied (free speed). As soon as torque is applied, rotational speed decreases and the governor allows more airflow through the motor.

A governor allows the tool to have higher output power at a relatively higher speed. On a governed tool, optimum power occurs between 75-90% of maximum RPM.

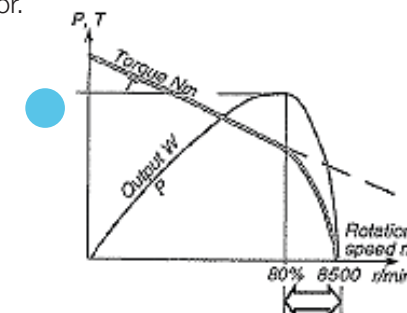

The optimum performance of the material removal tool occurs when the feed force applied gives the most material removal and the least amount of heat. Provided the cutting device is used, this is the point at which the power generated by the tool is the most efficient and the material removal is most effective.

Peripheral Speed

Peripheral speed is the speed at the edge of the cutting device, determined by its diameter and tool rotational speed. The equation is as follows:

Peripheral speed (m/s) = (wheel diameter x π/60) x rotational speed

Important

Abrasive and consumable manufacturers indicate both maximum peripheral speed and maximum rotational speed. These must never be exceeded.

Grinding and Sanding Overview

Overview

Grinding and sanding are the most popular tasks for pneumatic hand-held power tools. Within this broad category, we will look at three basic grinding and sanding applications: precision (die) grinding, rough grinding and cutting off, and sanding/polishing.

Precision Die Grinding and Deburring

Precision (die) grinding and deburring with hand-held tools is done to remove material from small areas or spots, and from cavities or other confined spaces. Creating cavities in a die and removing redundant material from narrow welds are typical precision or die grinding operations.

High Productivity

These tools provide a great boost to productivity because of their size, speed, and accessibility.

Tool Types Used

Dotco is an industry leader in small, precision type die grinders and are offered in both a rotary vane configuration and a turbine air motor that includes:

- Die grinders
- Pencil grinders
- Precision turbine grinders



HERMES
TOOLS

Common Applications

Other operations include deburring cast, stampings, and other manufactured parts or cut pieces of material including:

- Casting, die, and mold work
- Removal of gates, flashes, and parting lines
- Narrow welds and smoothing
- Production parts honing, finishing and/or polishing
- Deburring
- Cavity or confined space material removal
- Jewelry, dies, and intricate parts
- Etching and engraving
- Fine wood or plastic work

Common Grinding Operations

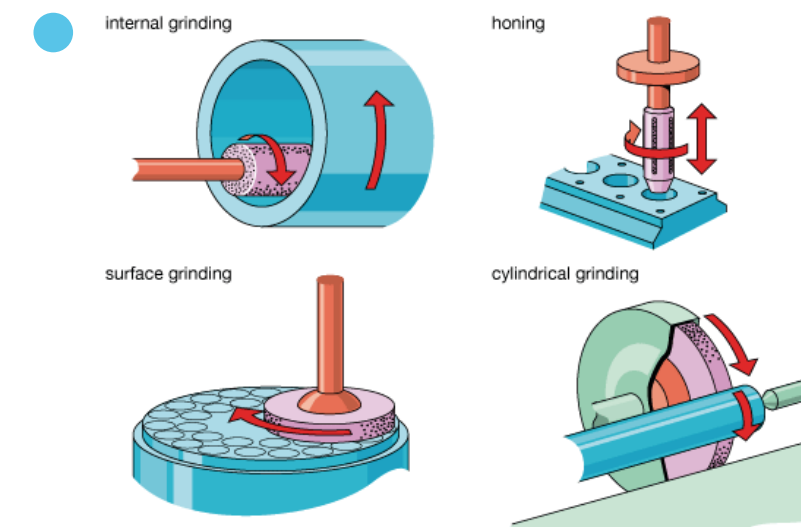

Common Cutting Devices (abrasives & consumables)

These abrasives and consumables include carbide burs made of tungsten carbide or high speed steel as shown below.



Also available are a variety of mounted points and modular mounted accessories as shown below and on the right.



HERMES
TOOLS

Industry Applications for Precision Die Grinding and De-burring

The industry applications using die grinding and de-burring power tools are varied but primarily include:

Light to Medium Manufacturing & MRO

- Tooling, casting, die, and mold manufacturers
- Parts and component manufacturers
- Stamped metal (including white goods)
- Composites and carbon fiber
- Signmaking

Artesian Manufacturing

- Jewelry and intricate production
- Furniture and woodworking
- Sculpture and monuments

Quality and Safety Critical

- Medical and scientific equipment
- Prosthetics and health care goods
- Aerospace
- Automotive



Cleco-Dotco® Precision Die Grinding and Deburring Tool Types

On this page are the most popular models and styles that the Cleco-Dotco® brand has to offer.

High Speed Turbine Grinder

Characterized by a high-speed turbine motor (typically 0.05-0.1 HP), some high speed turbine grinders are governed and most have front exhaust. They do not require lubrication and have a 1/8" collet.



Pencil Die Grinder

Powered by a rotary vane motor and mostly non-governed. pencil die grinders have front and rear exhaust and a 1/8" collet.



In-line Die Grinder

All in-line die grinders are rotary vane motor driven and typically range from 0.2 – 1.0 HP and have a 1/4" collet. They offer numerous variations and combinations of lengths, speeds, governing options, speed regulation, and housing material.

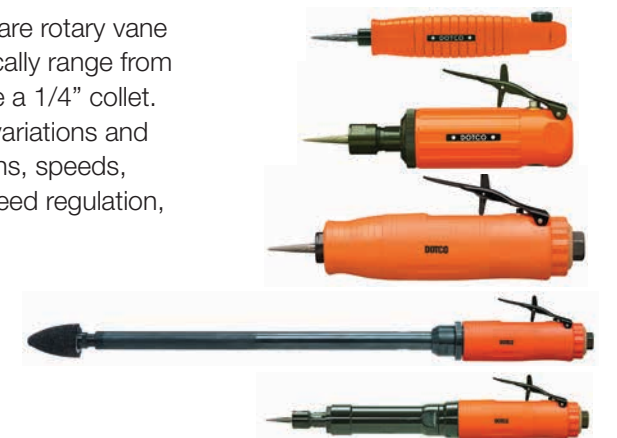

Angle Die Grinder

This type of grinder is characterized by an output spindle of a different axis than the motor and is driven by a rotary vane motor ranging from 0.2-1.0 HP with a 1/4" collet. Angle die grinders offer geared and non-geared angle head options. They offer many combinations of speeds, governing options, speed regulations, and housing materials.



Rough Grinding and Cutting Off

Rough grinding and cutting off involves removing redundant material from cast, forged, or welded pieces. It also involves leveling or smoothing edges and giving the piece or the welding the required shape. Additionally, the task can involve removing material to form a cavity or boring/internal grinding of an inner diameter surface.

High Productivity

These tools provide the power, size and weight needed for excellent productivity. However, the amount of redundant material to be removed, type of material, abrasive wheels, and consumables to be used need to be considered.

Tool Types Used

Cleco-Dotco® is an industry leader in Rough and Cutting Off grinders offering:

- Vertical grinders
- Depressed center wheel angle grinders
- Cone and plug wheel grinders
- Cut-off tools
- Horizontal grinders



Vertical Grinder



Angle Grinder



Horizontal Grinder

Common Applications

The variety of tool types creates many potential applications including:

- Large casting, die, and mold work
- Removal of gates, flashes, and parting lines
- Welds smoothing
- Large cavities
- Shaping
- Cutting and separating



Common Abrasives and Consumables

Abrasives and consumables for rough grinding and cutting off are diverse in shape and varied in texture depending on the task required. They include:



Depressed Center Wheel

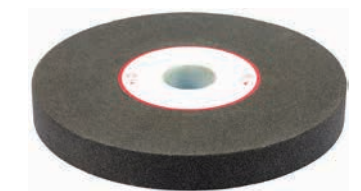

Straight Grinding Wheel



Cup Wheel

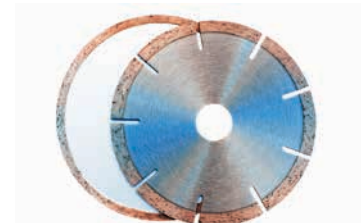

Cut Off Wheel



Flap Wheel



Cone or Plug Wheel

Abrasive Wheel Profiles

It's very important to choose the most efficient abrasive wheel for the application and match it to the material removal tool that will run it to full capacity.

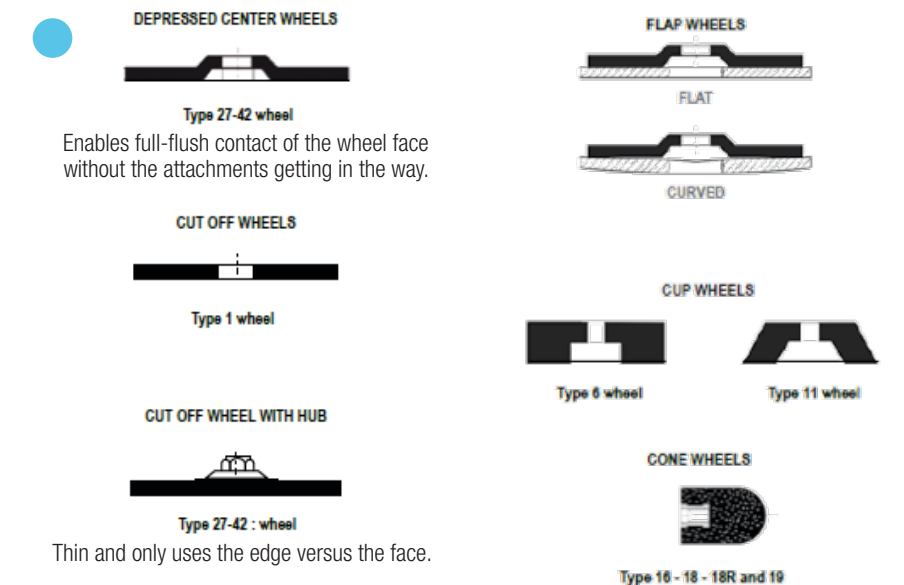

Common Abrasives and Consumables cont.

Abrasives

Lets take a closer look at the abrasive element used in material removal. The abrasive or grinding agent consists of small grains of either aluminum oxide (Al₂O₃) or silicon carbide (SiC), bonded together with phenolic resin or ceramics, and sometimes reinforced with a weaved fiber structure.

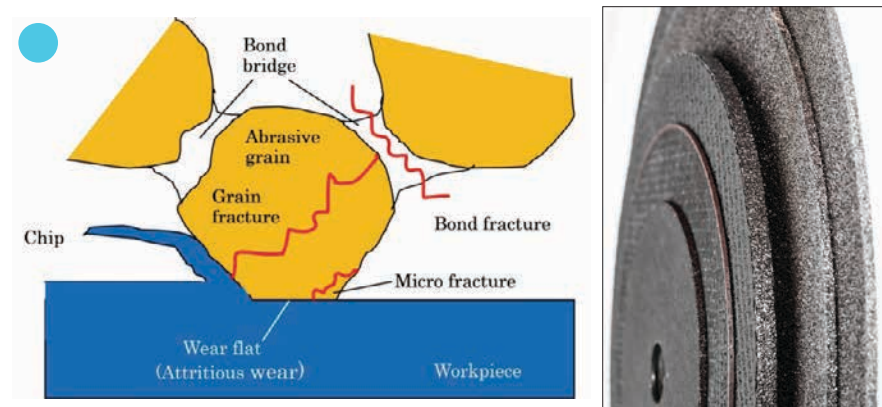

Illustration of abrasive at work

Close up of grinding abrasives

Grain Size and Function

Grain size and amount of resin (density) vary to suit the specific application and surface required. Like sandpaper, fine grains with softer bonding are ideal for grinding sharp edges or removing a thin layer; whereas coarse grains and harder bonding are more effective for large scale material removal or rough grinding, where feed force may be high.

Categorizing Abrasive Components

Different factors contribute to abrasive types and function. Some of those factors include:

- **Grading** abrasives is done according to grain composition, grain size, and hardness of bonding.
- **Material Composition** is indicated by 'A' for aluminum oxide and 'C' for silicon carbide.
- **Grain Size** is gauged by whether a certain size grain can pass through a density of mesh (mesh/inch) according to ISO 525:

- Coarse (8-24 mesh)	- Fine (80-180 mesh)
- Medium (30-60 mesh)	- Very Fine (220-400 mesh)
- **Hardness of Bonding** is classified using the letters C-X:

- Very Soft (C-G)	- Hard (P-S)
- Soft (H-K)	- Very Hard (T-X)
- Medium (L-O)	



Partner with Experts

Creating a partnership with an abrasive manufacturing representative (like 3M) or a distributor can result in an application based, solution-oriented approach to a new challenge.

HERMES
TOOLS

Industry Applications for Rough Grinding and Cutting Off

The general industry applications using rough grinding and cutting off are varied but primarily include:

Medium to Large Manufacturing

- Large die and mold
- Shipbuilding
- Railroad and rolling stock

Energy

- Mining
- Oil, gas, petrochemical
- Nuclear and power generation

Heavy Metal Working

- Pipes, structural, and construction
- Foundries and metal work
- Heavy production

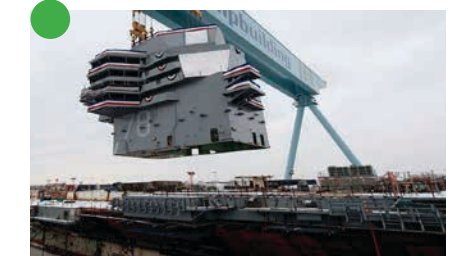

HERMES
TOOLS

Dotco® Rough Grinding and Cutting Off Tool Types

This page represents the most popular models and styles that Cleco-Dotco® offers.

Straight/Horizontal Grinders

The configuration is characterized by straight wheels or mounted cone or plug wheels. They use a spindle that is aligned with the output of the motor, which can range from 0.5 – 3.0 HP.

Guards are not necessary for mounted or cone wheels up to a diameter of 80mm provided they are used for internal grinding or honing.



Angle Grinder

These grinders are configured by a 90 degree angle between the motor shaft and the output spindle. Motor output can range from 0.5 – 3.0 HP. Angle grinders are mainly used with depressed center wheels and cutoff wheels. They are able to accept all other wheel types except mounted cones or plugs.

The use of the guard is required in all grinding circumstances. Numerous variations and combinations of lengths, speeds, governing options, speed regulation, and housing materials are available.



Vertical Grinders

Vertical grinders are typically the most powerful of all grinders and with the lowest RPM range. They usually use larger-sized abrasives up to 9". They are designed for heavy industrial use, typically in the harshest environments. The output spindle and motor shaft are aligned with the motor output, usually in the 2 - 4 plus HP range.

The use of the guard is required in all grinding circumstances.



Sanding and Polishing

Many manufactured products must meet requirements regarding surface or finish. The surface of basic materials, such as sheet metal, is the result of the production process. To obtain a smoother, more even surface in manufacturing (or repair), rough peaks on the surface have to be removed, or sanded. Finally, if a very smooth surface is required, using a liquid and polishing consumable can be an effective way to obtain a fine finish and even out contours.

High Productivity

Sanding and polishing applications often involve abrasive sanding discs or flap type wheels that need to be used with the correct RPM and tool type for maximum efficiency. The highest productivity occurs when the correct power, type of tool providing the best work accessibility, and abrasives are aligned.

Tool Types Used

Cleco-Dotco® is an industry leader in rough and cutting off grinders offering:

- Vertical sanders
- Angle sanders and polishers
- Palm and random orbital sanders
- In-line sanders
- Belt sanders
- Other pneumatic tools with sanding attachments



Common Abrasives and Consumables

Abrasives and consumables for sanding and polishing come in all shapes, flexibility, and textures including:



Industry Applications for Sanding and Polishing

The general industry applications using sanding and polishing tools are numerous but primarily include:

Medium to Large Manufacturing

- Surface preparation and repair
 - Automotive
 - Aerospace
 - Recreational vehicle
 - Mobile home
 - Marine and shipbuilding
 - Rail
 - Maintenance, repair and overhaul



Small to Medium Manufacturing

- Furniture and woodworking
- Composites manufacturing



To protect operators from exposure to air borne contaminants, many operations use vacuum attachments to collect dust from sanding applications.



Cleco-Dotco® Sanding and Polishing Tool Types

Here are the most popular models and styles that Cleco-Dotco® offers including rotary, orbital and belt sanders.

Orbital Sanders

Small eccentric movements of the pad, which sets the grains in motion to rub off the edges of the uneven surface.

Orbital sanders typically use sanding discs or sand paper (PSA or Hook and Loop), Popular orbit patterns are 3/16" or 3/32" and come with one or two-handed grips. They may include a central vacuum feature.



Random Orbital Sanders

Random orbital sanders feature a superimposed rotating movement that is produced during every orbital rotation. This combination creates an orbital movement which also moves in circles.



The Random orbital sander uses the edge rather than the face of the flap or bristle wheel. Consumables are shaped abrasives on an attachment shank.

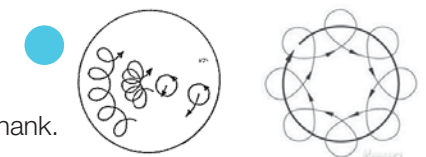

Belt Sander

Belt sanders use belt-shaped abrasives, which come in a variety of lengths and widths to suit the application. They are ideal for deburring and finishing in tight areas or where sanding has to conform to a contour.



Die Grinder

Belt sanders can offer an attachment or modification to a die grinder, which includes a drive spindle, an arm, and a roller that accepts belt-like abrasives. These are then used to sand corners, inner surfaces, small spots, and other tight work surfaces requiring the accessibility of the belt sander.



Belt Sanding Attachment

Percussion (Piston) Sanders

This sander uses reciprocating motion to remove material rather than rotary. Its driven by air moving through valves and shuttling a piston back and forth.





Overview

Many industry sectors require handmade cylindrical voids, holes, and cavities in a variety of materials. These materials include wood, aluminum, steel, composite, and glass. Drilling becomes a critical task in these operations whether they are in production, assembly or repair. On the following pages are hand-held pneumatic drilling tools, their accessories and industry applications, and available drills types.

High Productivity

Hand-held drilling tools offer excellent productivity when you consider the right combination of power, tool type for maximum work access, and drill bit selection.

Tool Types Used

Cleco-Dotco® offers some of the industry's most durable and reliable hand-held drills including:

- *Pistol grip drills*
- *In-line drills*
- *Angle drills*

Common Applications

The variety of drill styles and attachments designed for the drill chuck create many application possibilities including:

- *Drilling*
- *Boring*
- *Tapping*



HERMES
TOOLS

Cleco
DOTCO®

Common Drill Bits

Drill bits are designed for the function to be performed as well as the materials meant to be drilled, bored, or tapped. Below are some of the more common bit designs.

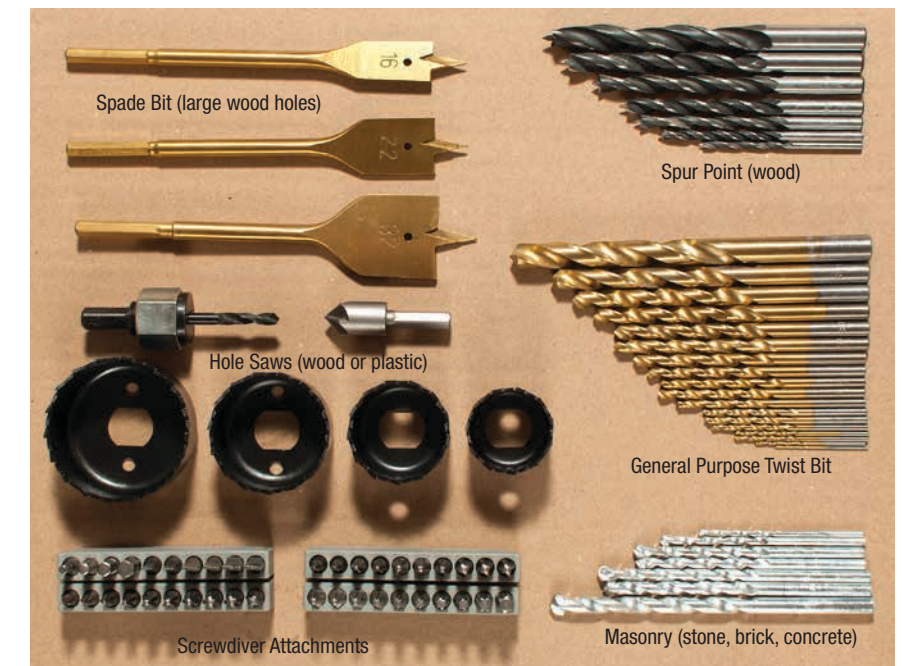

Drill Bit Overview

Examples of Twist Bits:



Drill Bit Material

Most drill bits are made of high speed steel. For highly abrasive materials such as carbon fiber or Kevlar fiber, a cemented-carbide bit is used or even a heavier duty material. The surface treatment is usually steam-tempering, creating a smoother surface with less friction during drilling.

Twist Bit Breakdown

The **Point Angle** is normally 118°, but can vary from 118-135°, depending on the type of drill bit

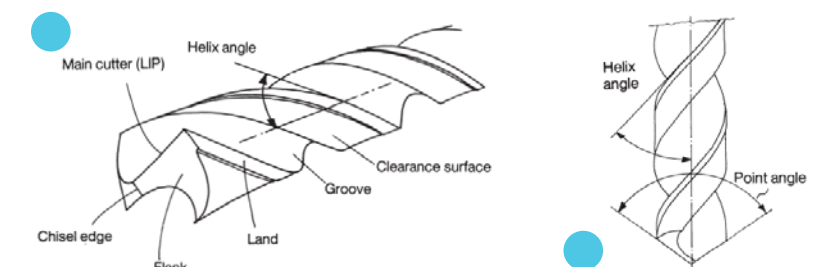

Helix Angle (above right) is a design based on the material to be drilled. Large helix angle bits are usually for long-chipping material like aluminum, copper, and other soft material. Short helix angle bits are usually for short-chipping materials like brass, bronze, hard rubber, and certain plastics.

HERMES
TOOLS

Cleco
DOTCO®

Drill Bit Selection Guide

Below is a comprehensive guide outlining the key factors to consider for selecting the correct drill bit including materials, speed, RPM, and hole size.

MATERIAL	SPEED (SFPM)		DRILL SIZES – INCHES (mm)				DRILL SIZES – INCHES (mm)									
	MIN.	MAX.	1/16 (1.5)		1/8 (3)		3/16 (5)		1/4 (6)		5/16 (8)		3/8 (10)		1/2 (13)	
			0.063	0.125	0.188	0.250	0.313	0.375	0.500	MIN. RPM	MAX. RPM	MIN. RPM	MAX. RPM	MIN. RPM	MAX. RPM	MIN. RPM
MARBLE	15	25	909	1,515	458	763	304	507	229	381	183	305	152	254	114	190
SLATE	15	25	909	1,515	458	763	304	507	229	381	183	305	152	254	114	190
STONE	15	25	909	1,515	458	763	304	507	229	381	183	305	152	254	114	190
STEEL – ALLOY (300-400 Bhn)	20	30	1,212	1,818	811	916	406	609	305	458	244	366	203	305	152	229
CAST IRON – HARD (260-320 Bhn)	30	40	1,818	2,425	916	1,222	609	812	458	611	366	488	305	407	229	305
STEEL – STAINLESS (375-425 Bhn)	30	40	1,818	2,425	916	1,222	609	812	458	611	366	488	305	407	229	305
MONEL	40	60	2,425	3,031	1,222	1,527	812	1,015	611	763	488	610	407	509	305	381
STEEL – AUTOMOTIVE FORGINGS	40	60	2,425	3,031	1,222	1,527	812	1,015	611	763	488	610	407	509	305	381
STEEL – TOOL (150-200 Bhn)	50	60	3,031	3,637	1,527	1,833	1,015	1,219	763	916	610	732	509	611	381	458
STEEL – 0.4-0.5%C (125-175 Bhn)	70	80	4,244	4,850	2,139	2,444	1,422	1,625	1,069	1,222	854	976	713	814	534	611
CAST IRON – MED HARD (150-190 Bhn)	70	100	4,244	6,063	2,139	3,055	1,422	2,031	1,069	1,527	854	1,220	713	1,018	534	763
BRONZE – HIGH TENSILE	30	100	1,818	6,063	916	3,055	809	2,031	458	1,527	366	1,220	305	1,018	229	763
MALLEABLE IRON	80	90	4,850	5,458	2,444	2,750	1,625	1,828	1,222	1,375	976	1,098	814	916	611	687
MILD MACHINERY – 0.2-0.3%C (120-150 Bhn)	80	110	4,850	6,669	2,444	3,361	1,625	2,234	1,222	1,680	976	1,342	814	1,120	611	840
BAKELITE AND SIMILAR MATERIAL	100	150	6,063	9,094	3,055	4,583	2,031	3,047	1,527	2,291	1,220	1,830	1,018	1,527	763	1,145
CAST IRON – SOFT (110-140 Bhn)	100	150	6,063	9,094	3,055	4,583	2,031	3,047	1,527	2,291	1,220	1,830	1,018	1,527	763	1,145
PLASTIC – SOFT	100	150	6,063	9,094	3,055	4,583	2,031	3,047	1,527	2,291	1,220	1,830	1,018	1,527	763	1,145
BRASS AND BRONZE	200	300	12,126	18,189	6,111	9,167	4,063	6,095	3,055	4,583	2,440	3,661	2,037	3,055	1,527	2,291
ALUMINUM & ALUMINUM ALLOYS (CAST, NON-HEAT TREATED)	200	300	12,126	18,189	6,111	9,167	4,063	6,095	3,055	4,583	2,440	3,661	2,037	3,055	1,527	2,291
MAGNESIUM AND ALLOYS	250	400	15,157	24,252	7,639	12,223	5,079	8,127	3,819	6,111	3,050	4,881	2,546	4,074	1,909	3,055
FIBERGLASS	300	400	18,189	24,252	9,167	12,223	6,095	8,127	4,583	6,111	3,661	4,881	3,055	4,074	2,291	3,055
WOOD	300	400	18,189	24,252	9,167	12,223	6,095	8,127	4,583	6,111	3,661	4,881	3,055	4,074	2,291	3,055
RPM RANGES			RPM RANGES													
LOW	0	301	601	901	1,201	1,801	2,401	3,001	3,601	4,201	5,001	6,001	7,001	8,001	9,001	10,001
HIGH	300	600	900	1,200	1,800	2,400	3,000	3,600	4,200	5,000	6,000	7,000	8,000	9,000	10,000	25,000

Industry Applications for Hand-held Pneumatic Drills

The general industry applications for hand-held pneumatic drills are numerous but primarily include:

Light to Medium Industry

- Pre-assembly drilling
- Sheet metal fabrication
- Composite fabrication
- Stainless steel
- Mobile home fabrication
- Furniture and woodworking



Large Industries

- Automotive and MRO
- Aerospace
- Construction
- Marine and rail
- Shipbuilding



Cleco-Dotco® Pneumatic Drill Tool Types

Below are the Cleco-Dotco® most popular pneumatic drill models and styles.

Pistol Grip Drills

Pistol grip drills are the most common style of pneumatic drill. They are best for a horizontal drilling axis or when the work piece is below the operator. Chuck sizes usually vary between 1/4” to 1/2”. Options include governor, reverse switch and auxiliary handle.



Note: See pages 40-43 “Pistol Grip Drills” in the current Dotco® catalog.

Angle Drills

Angle drills use short drill bits to access tight or cramped spaces. They are popular in aerospace and other industries where confined area drilling is required. Angle drills come in a variety of configurations to optimize accessibility.



Note: See pages 44-43 “Right Angle Drills” in the current Dotco® catalog.

In-line Drills

In-line drills are ideal for drilling vertical holes along the sight line of the operator. They are also great for drilling in cramped and awkward spaces where an in-line configuration is required.



In-line drills are the lesser used version of hand-held drills.

Note: See page 40 “In-line Drills” in the current Dotco® catalog.





Overview

When hard material removal action is required in a confined space, percussion material removal tools are used. Percussion tools are characterized by a valve-activated piston motor that delivers repeated blows to a cutting device and transfers the energy to the work piece itself. Based on the configuration of the tool and the cutting device, percussion tools can be used to shape, cut, break, scale, remove, level, and deform the work piece.

High Productivity

Hand-held pneumatic percussion tools offer excellent productivity when the right combination of stroke length, hitting power, type of tool, cutting device, and ergonomics selection are considered.

Tool Types Used

Cleco-Dotco® offers some of the industry's most durable and reliable hand-held pneumatic percussion tools including:

- Triple (piston) scaler
- Rivet hammers
- Chipping hammers
- Scalers (needle and chisel)

Common Applications



The variety of percussion tool styles and attachments creates many application possibilities including:

- Surface preparation (rust or paint removal)
- Compacting sand, soil, and other mixtures
- Coarse cutting, hole making, and roughening of metal
- Closing rivets
- Automotive body work
- Scraping, leveling, and contouring
- Removal of scale, slag, and other residues
- Removal of excess material (fettling) from castings
- Trimming and light demolition of concrete and other building materials

HERMES
TOOLS

Common Percussion Cutting Devices

Percussion cutting devices are designed for the functions of hammering, chipping and chiseling. Below are some of the more common attachment designs.



Chisels



Needles



Rivet Sets



Cutting & Specialty Chisels

Industry Applications for Hand-held Pneumatic Drills



The general industry applications for hand-held pneumatic percussion tools are numerous but primarily include:

Medium to Large Industries

- Aerospace riveting
- Recreational vehicle and mobile homes
- Metal working, foundries, steel fabrication, piping, construction material
- Marine and shipbuilding
- Rail
- Structural maintenance, repair, and overhaul
- Energy, petrochemical, refineries, heat exchanger
- Construction, road paving, masonry, concrete, demolition

Small to Medium Industries

- Industrial MRO
- Automotive body work and specialty repair
- Emergency rescue

HERMES
TOOLS

Safety With Pneumatic Percussion Tools

Operations with pneumatic percussion tools need additional safety considerations including:



Always use an inspected cutting device retainer.



Always wear PPE, goggles, ear protection, HD Gloves, respiratory apparatus, and helmet.



If a cutting device breaks during use, always disconnect tool and cutting device after use or when changing cutting tools.



Because of the debris created by percussion tools, isolate work areas by using barriers and stations. Never work near explosive gasses.



Never dry run (trigger idle blows to) a percussion tool. It may discharge the cutting device and damage the tool.

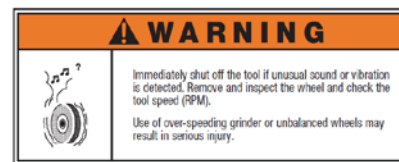

Always follow the provided Safety Rules and Service Instructions.



If a tool functions with much heavy vibration, use anti-vibration gloves or minimize its use until it can be repaired or replaced.



Separate all coupling from the tool by a whip hose.

Cleco-Dotco® Pneumatic Percussion Tool Types

The following are the most popular pneumatic percussion tool models and styles that Cleco-Dotco® offers.

In-line and Angle Scalars

Scaler tools are used to remove scale, rust, paint, coatings, welding slag, and deposits. Scalars come in different (stroke) lengths, actuation mechanisms, and configurations. A needle scalar is the same as a chisel scalar with a needle holder attachment and needle cutting device.

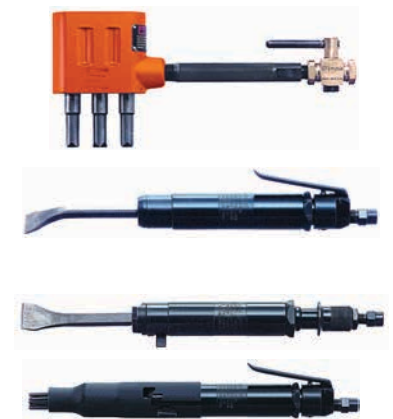

Note: See pages 56-57 "Percussion Tools" in the current Dotco® catalog.

Riveters/Air Hammers

Riveters and air hammers are used to drive rivets when coupled with a rivet set. They can use various chisels as the cutting device for light duty material removal, sheet metal work, and reshaping. Riveters and air hammers are also available with an anti-vibration design and a variety of stroke lengths, holder diameters, and holder styles.



Note: See pages 56 "Percussion Tools" in the current Dotco® catalog.

Chippers/Chipping Hammers

Chippers and chipping hammers are designed for light demolition, heavy material removal, and hole making in a variety of medium to heavy industries. They are available in several varieties of stroke lengths, handle styles, chisel retaining mechanisms, and trigger designs.



Note: See page 56 "Percussion Tools" in the current Dotco® catalog

Basic Troubleshooting for Pneumatic Tools

Below are some basic troubleshooting tips when encountering problems with pneumatic tools.

- Make sure the supplied air line is filtered, regulated, lubricated and meets volume and pressure requirements (typically 90 PSI) at the inlet of the tool.
- Obey all warnings, safety, and installation instructions on both the tool and the cutting device. Keep tools oiled and lubricated based on manufacturer's recommendations.
- If the tool is stalled, blows air, runs without the trigger depressed, has missing components or visible damage, please return it to an authorized repair facility.
- If the tool runs when the trigger is activated, use a tachometer to measure the RPM and/or BPM of the tool and ensure that it is within the proper operating limits. Note that for industrial grinders, the running RPM should not exceed the rated RPM of the tool.
- Listen for any abnormal noises when the tool is running at free speed and under load.
- Visually check for leakages of air, oil or grease.
- Feel for temperature rise or abnormally high vibration while the tool is running at free speed.
- Never refurbish a tool's safety features. Always replace.

Dotco® Specific Model Numbering System

Until we complete the transition of all products under the Cleco® umbrella brand, here is the formula to our Dotco® product model numbers as shown below:

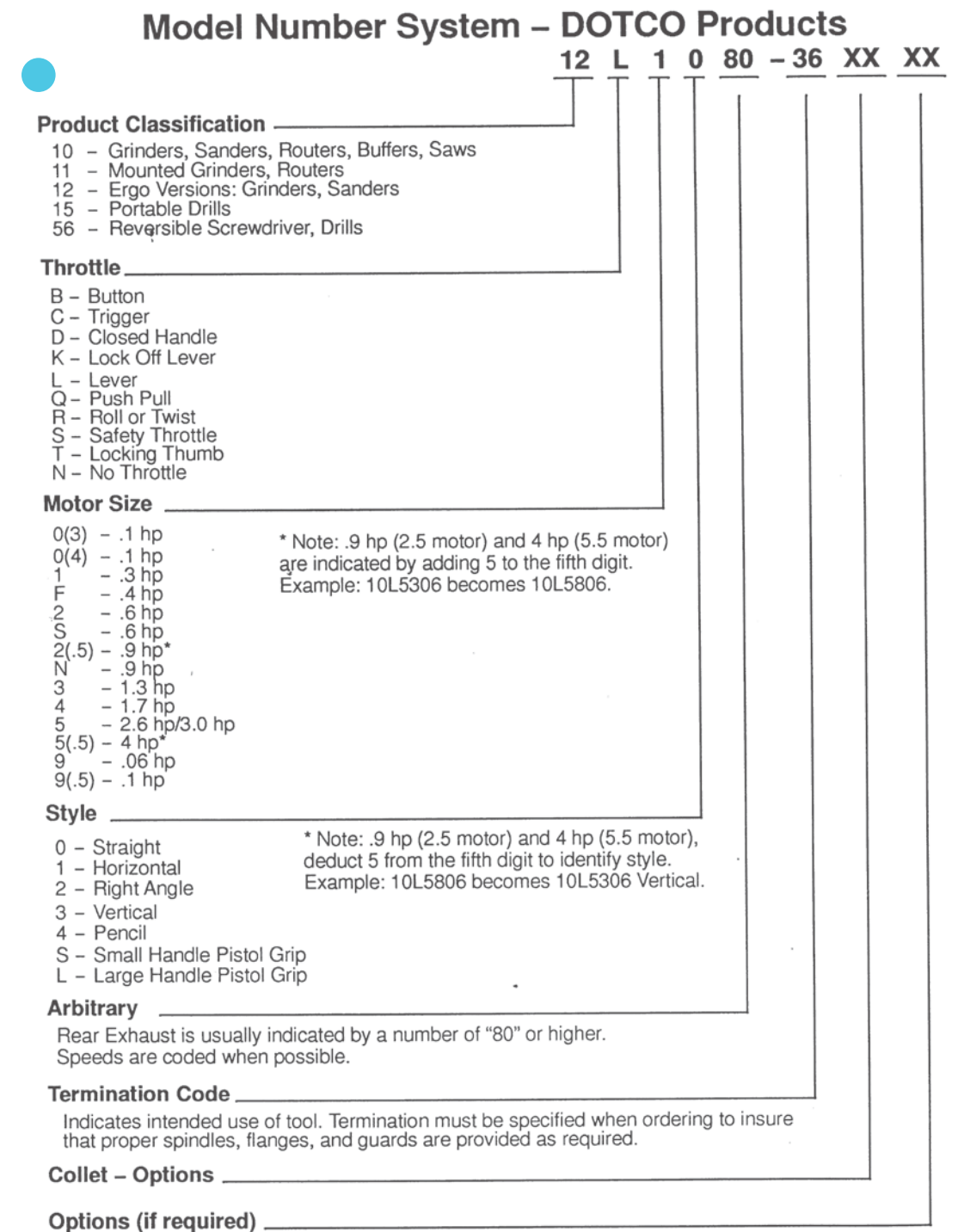

Cleco® Specific Model Numbering System

Until we complete the transition of all products under the Cleco® umbrella brand, the formula to our Cleco specific material removal product model numbers are as shown below:

Cleco® Small Grinders

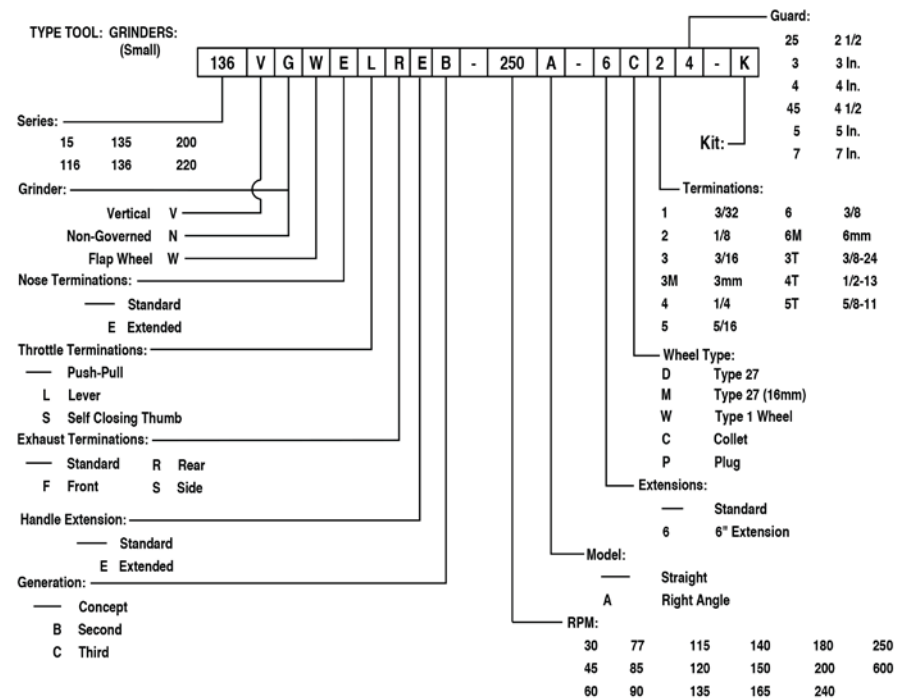

Cleco® Large Grinders

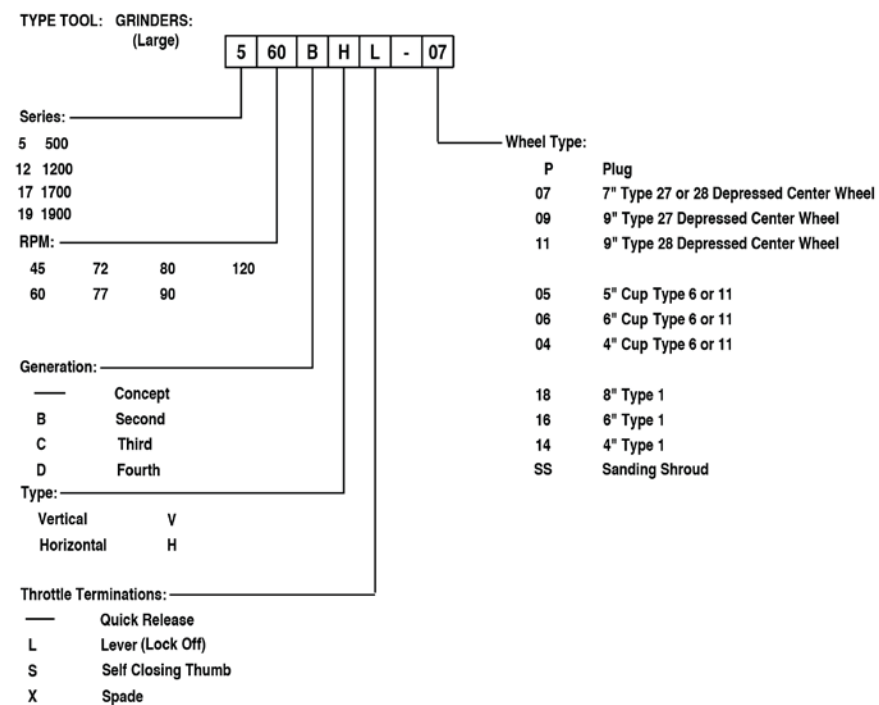



Apex Tool Group

670 Industrial Drive
Lexington, SC 29072
Phone: 800-845-5629
Phone: 919-387-0099
Fax: 803-358-7681

www.cleco-tools.com

www.dotco-tools.com

Apex Tool Group Service Center

1000 Glengarry Drive,
Fairdale, KY 40118
Phone: 502-708-3400



HERMES

TOOLS

HERMESTOOLS Sp. z o.o.
ul. Sarni Stok 73 a, 43-300 Bielsko-Biała, Polska; tel: +48 33 821 41 90-91
www.hermestools.eu